

2019

**STANDARD
GOLF[®] COMPANY**
EMPLOYEE OWNED

WORLD'S MOST
COMPLETE LINE OF
GOLF COURSE
ACCESSORIES



STANDARDGOLF.COM

AT HOME ON THE RANGE

2018 was a monumental year in the 108-year history of Standard Golf Company. The Voorhees Family sold the business to the employees of Standard Golf. As such, Standard Golf is now a 100% employee owned ESOP. Pride in ownership and company is what allows us to continue to Set The Standard in Golf Course Accessories.

"Top quality products, like these range ball pickers, and providing the best value possible is Standard Golf's mission. The true measure of excellence is having great people in place who consistently provide our customers with the ultimate buying experience."

- Peter Voorhees, President



Turn to page 52 to learn more about Magnum Ballpickers

New Products	4-7
Ball Washers	8-9
Bunker Rakes	10-13
Club Washers	14
Cups	15-18
Divot Mix Caddies	19
Divot Mix Storage	20-22
Fixtures & Benches	23
Flags	24-31
Flagsticks	32-34
FootGolf Accessories	35
Hazard Markers	36-37
Hole Cutters & Shells	38-39
Maintenance & Turf Tools	40-45
Marking Paint	46-47
Practice Green	48-51
Range Equipment & Accessories	52-58
Rope & Chain Stakes	59-60
Safety Equipment	61
Signs	62-68
Spike Cleaners	69-70
Tee Consoles	71-75
Tee Markers	76-80
Tee Towels	81
Trash Containers	82-84
Water Stations	85-87
Yardage Markers	88-90
ProLine	91
Think Pink	92
Parts List	93-99

KEY

NEW! = New product

ADD YOUR LOGO = Product that can be personalized

LIMITED SUPPLY = Product has limited supply available

♻️ = Recycled product

NEW FOR 2019

THE CHIEF BUNKER RAKE

The Chief is designed to work with the "Aussie Style" of bunker maintenance. This tine-less (toothless) rake has two sides: one smooth side to pack down the vertical sides of the bunker and another side with ridges to rough up the bottom of the bunker without leaving large grooves (plow marks) in the sand.



		GATOR GRIP HANDLE	ALUMINUM HANDLE	GATOR GRIP HANDLE
	HEAD ONLY	72" (183 cm)	54" (137 cm)	60" (152 cm)
	20" (50.8cm)	7/8" D (2.2 cm)	7/8" D (2.2 cm)	7/8" D (2.2 cm)
Green	-	11920*	11900**	11910**
Black	11901	-	-	-

*Part number 11920 ship in a box of 6.
**Part numbers 11910 & 11900 ship in box of 12.

MAGNUM SENIOR HARVESTER BALL PICKER

Double the power of the Jr. Harvester. Side-by-side baskets give the Magnum Senior Harvester Ball Picker a 600-ball capacity. Easily push around a practice green, chipping area or even a small driving range.

- ▶ Uses our patented split gang technology.



Actual Weight: 60 lb (27 kg)
Shipping Weight: 108 lb (49 kg)

Magnum Senior Harvester Ball Picker	85400
-------------------------------------	-------

IN-LINE MAGNUM HARVESTER BALL PICKER

Looking for a range ball picker that will not break the bank, but still can do the heavy lifting? Standard Golf's new In-line Magnum Harvester Ball Picker is the latest in the line of well-made range ball pickers from Standard Golf. Attach directly to a utility cart.

- ▶ Uses our patented split gang technology
- ▶ 5' wide with a 900-ball capacity
- ▶ Picks golf balls going forward or reverse

Actual Weight: 128 lb (58 kg)
Shipping Weight: 178 lb (81 kg)

In-Line Magnum Harvester Ball Picker	85500
--------------------------------------	-------

DELUXE RANGE BALL CRATE

Dress up your driving range with our new Deluxe Range Ball Crate. With a capacity of 250 range balls, this new crate will give your range a sophisticated look. Made from the same material as our Recycled Bag Stands to complete your range.

20.5" W x 10" D x 9" H (52 cm x 25.4 cm x 22.9 cm)

Green	100150GN
Black	100150BK
Brown	100150BR



PREMIERE BAG STAND

Hitting the range with all your tools means you need more places to set your items. Our Premiere Bag Stand comes with cut out components for your tees, mobile phone, car keys, and beverage. Set your full bag inside the stand or take individual clubs and rest them in the notches for each club. The top and bottom of this bag stand will always be black, but the "stand" can be green, black or brown.

28" H x 19" W (71 cm x 48 cm)

Green	100810GN
Black	100810BK
Brown	100810BR

Some assembly required



DELTA FLAT BENCH

Made from recycled plastic these benches will not warp, splinter or rot. No need to paint or stain. We offer the flat bench in two sizes, 4' (1.2 m) and 6' (1.8 m) and have three colors for each: Brown, Black and Green.

Note: the legs will always be black.

4' (1.2 m) BENCH
11.25" (28.6 cm) depth
17.5" (44.5 cm) height

6' (1.8 m) BENCH
11.25" (28.6 cm) depth
17.5" (44.5 cm) height

Green	400400GN	400500GN
Black	400400BK	400500BK
Brown	400400BR	400500BR



ROCK ISLAND BACK BENCH

Made from recycled plastic these benches will not warp, splinter or rot. No need to paint or stain. We offer the flat bench in two sizes, 4' (1.2 m) and 6' (1.8 m) and have three colors for each: Brown, Black and Green. **Note:** the legs will always be black.

4' (1.2 m) BENCH
16.75" (42.5 cm) depth
33" (83.8 cm) bench height

6' (1.8 m) BENCH
16.75" (42.5 cm) depth
33" (83.8 cm) bench height

Green	400200GN	400300GN
Black	400200BK	400300BK
Brown	400200BR	400300BR



NEW FOR 2019

DELUXE STEEL COMBO ROPE & CHAIN STAKE

- ▶ Available in three colors (chrome, green and yellow).
- ▶ Stakes allow the user to string across either rope or chain.
- ▶ New smaller 3/8" (0.95 cm) diameter to help reduce weight and shipping costs.
- ▶ Choice of either a 25" (63.5 cm) or 36" (91 cm) above ground stake.
- ▶ A 10" (25.4 cm) spike is attached.

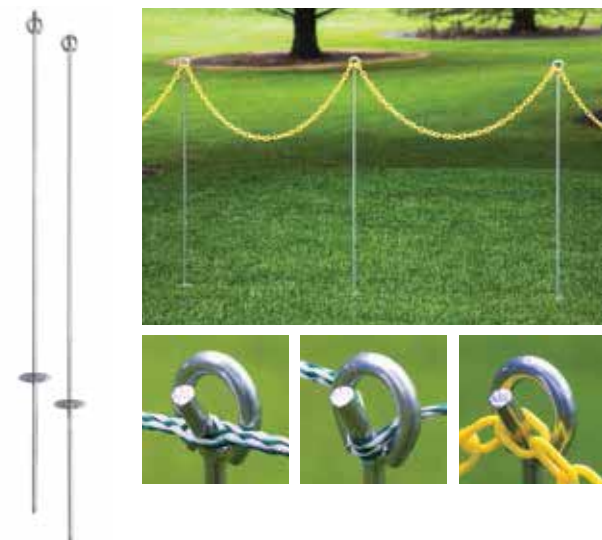

Sold in sets of 12	DELUXE STEEL COMBO ROPE & CHAIN STAKE	
	25" (63.5 cm)	36" (91.44 cm)
Green	38330	38430
Chrome	38310	38410
Yellow	38320	38420



RECYCLED DIVOT MIX BOTTLE RACK

Changing with the times. Our new Divot Mix Bottle Rack can now accept 40 oz (1.2 L) bottles with and without handles.

- ▶ Capacity is 24 bottles.
- ▶ Accommodates bottles with and without handles.

60" H x 41" W x 16" D (152 cm x 104 cm x 41 cm)

Green	200135GN
Brown	200135BR
Black	200135BK

Bottles not included.

SEED & SOIL BOTTLE W/HANDLE

New to the line-up of seed and soil bottles is Standard Golf's 40 oz (1.2 L) bottle with handle and rattle proof lid.



Seed & Soil Bottle w/Handle	18955
-----------------------------	-------

STANDARD TEE/YARDAGE MARKER

New and Improved tee and yardage marker that will not harm mowers. This rubber textured product has UV stabilizers and color fast throughout. Will not show different color if cut and will not chip.

- ▶ Made from a synthetic polymer for a lighter and more durable construction.
- ▶ Recessed center of the marker is perfect for adding specific distance or club/event logos.
- ▶ 4" diameter decals are available for Standard Yardage and Tee Markers (call for pricing).

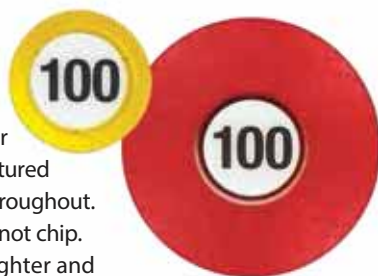

RUBBER TEE/YARDAGE MARKER

	6" (15.25 cm)	11" (27.94 cm)
Red	09010	09020
White	09011	09021
Blue	09012	09022
Yellow	09013	09023

5 1/2" (14 cm) spike

DOUBLE-SIDED DYE-SUB FLAG

- ▶ Read flags from both sides with double-sided images.
- ▶ Combine images to make flag appear as two different flags—club logo on one side, tournament logo on the other.
- ▶ Construction includes liner between layers to limit "image show through".



	Single	Set of Nine
14" x 20" (35.6 cm x 50.8 cm)		
Full Coverage Double-Sided Dye-Sub Flag (Tube-Lock)	25802T	25800T
Full Coverage Double-Sided Dye-Sub Flag (Grommets)	25802	25800

Minimum order of nine. Each flag design can be individually customized. Art charges may apply.



CLUB FLAG

- ▶ Match your on-course pin flags with a flag for your club!
- ▶ Roughly 3' x 5' (0.91 m x 1.52 m) these flags are big and will be seen – perfect to fly on your club's flagpole, hang near scorer's table or even in your maintenance shop.
- ▶ Polyester flag material with sewn-in grommets.
- ▶ Quad stitching throughout flag.

	SINGLE 3'H x 5'W (91 cm x 152 cm)	SINGLE 4'H x 6'W (122 cm x 183 cm)
Full Coverage Customized Club Flag	25835	25846

RECYCLED 4" X 4" CHAMFER POSTS

These recycled posts are a great look and finish to your tee signs or other course signage. The best part? The economical price and you are helping the environment.



RECYCLED 4" X 4" CHAMFER POSTS
4" x 4" x 72"
(10 cm x 10 cm x 183 cm)

Green	400800GN
Black	400800BK

STANDARD CUP COVER

- ▶ Economical cover "fills" top of hole; doesn't damage mowers.
- ▶ Sits on top of the cup, flush with surface of the green.
- ▶ Made from synthetic polymer for a lighter and more durable construction.



1" (2.5 cm) high 4 3/16" (10.6 cm) diameter

Green	18510
-------	-------

STANDARD HOLE REDUCER

- ▶ Sits flush on top of the cup to reduce size of cup opening by 1" (2.5 cm).
- ▶ Helps players fine-tune putting skills.
- ▶ Ideal for practice greens.
- ▶ Made from a rubber textured material that has UV stabilizers and colorfast throughout.



1" (2.5 cm) high 4 3/16" (10.6 cm) diameter

Green	18010
-------	-------

PUTT-SAVER TOURNAMENT FLAGSTICK

COMING SPRING 2019!



Beginning in January 2019, both the USGA and R&A have changed the rules of golf to allow a player to leave the flagstick in the hole while putting from the green. This new rule will help speed up play, but with Standard Golf's "Putt-Saver" Technology may also help you drain a few more putts.

The Putt-Saver Technology is a precisely tapered flagstick angled to direct your ball into the cup.

In addition to the Putt-Saver Technology, this new flagstick will also come in two pieces – saving costs when shipping. With a reinforced steel rod and color fully-absorbed throughout the flagstick, this is the new leader in the clubhouse.



		7 1/2" (2.3 m) height
White	26350	–
Yellow	26360	–
White/Black	–	26370
White/Red	–	26380
Yellow/Black	–	26390

WORLD-CLASS WASHERS! FIRST-CLASS VALUES



Don't see a color you like? We can help! Call us at 1-866-743-9773.

PREMIER BALL WASHER (SINGLE BALL)

- ▶ Mounts over-the-post for added structural integrity.
- ▶ Easy to maintain with large drain and tamper-resistant, leak-proof drain plug.
- ▶ Simple design, only one moving part.
- ▶ New and improved brush design.

Capacity: 7.5 pints (3.6 L)

Red	01425
Green	01450
Black	01470

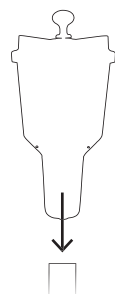

INSTALLATION

All washers mount on any Standard Golf ball washer or console stand or attach to any 2 3/8" (6 cm) O. D. post. See page 74 for more installation options.



Don't see a color you like? We can help! Call us at 1-866-743-9773.

MEDALIST BALL WASHER (SINGLE BALL)

- ▶ Economical compact package with sleek, tapered frame.
- ▶ Mounts inside the post.
- ▶ Simple design, only one moving part.
- ▶ New and improved brush design.

Capacity: 3.25 pints (1.6 L)

Red	01525
Green	01550
Black	01570

CLASSIC BALL WASHER (FOUR BALL)

- ▶ Our most popular washer.
- ▶ Rugged. Affordable.
- ▶ Available in six different colors.
- ▶ Crank-style washer with four ball capacity.
- ▶ Built-in overflow tubes prevent leaks and soap build-up.
- ▶ New and improved brush design.

Capacity: 3.7 pints (1.8 L)

Red	01325
Green	01350
Black	01370
Yellow	01300
Brown	01340
Blue	01375

Side Case Engraving – Black, Gold or White	01398
--	-------



Free engraving on orders of nine or more when using same logo.

SPARKLEEN ECOMAX DETERGENT TABLETS

- ▶ New environmentally friendly, concentrated formula only requires one tablet per ball washer for optimal cleaning power.
- ▶ Fizzing action dissolves tablet quickly in any water temperature. No measuring, no waste.
- ▶ Anti-bacterials keep solution fresh, even in hot weather.
- ▶ Unlike other brands, Sparkleen does not contain bleach.

450-Count Jar	03100
---------------	-------



SPARKLEEN LIQUID DETERGENT





- ▶ Concentrated formula. Economical to use – just 0.5 oz (14.2 ml) per ball washer.
- ▶ Formulated for use in all brands of ball washers, including range ball washers.
- ▶ Won't damage washers or internal parts.
- ▶ Will not become rancid in hot weather.
- ▶ Sold as a single gallon jug or a case of 4, 1-gallon jugs.
- ▶ Does not contain bleach.
- ▶ Non-corrosive.



	1-gallon (3.8 L) container	1-gallon (3.8 L) containers 4-gallon case
Sparkleen Gallon	03302	03300

BUILD YOUR OWN BUNKER RAKE

Use the chart below to see which bunker rake head and handles will fit together. Mix and match to build your own Standard Golf bunker rake.

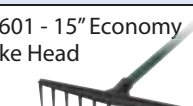
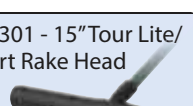
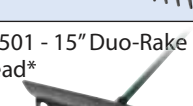
Rake Heads	Rake Handles														
	11605 - 48" (122 cm) Wood	11626 - 48" (122 cm) Wood	12305 - 54" (137 cm) Ultralight	12306 - 54" (137 cm) Ultralight	11200 - 60" (152 cm) Gator Grip	11201 - 60" (152 cm) Gator Grip	11210 - 72" (183 cm) Gator Grip	11211 - 72" (183 cm) Gator Grip	11710 - 54" (137 cm) Composite	11205 - 54" (137 cm) Aluminum	11515 - 54" (137 cm) Aluminum	11516 - 54" (137 cm) Aluminum	11532 - 64" (162.5 cm) Aluminum Curved	11542 - 64" (162.5 cm) Aluminum Curved	12205 - 72" (183 cm) Composite
Handle Color	Yellow	Green	Yellow	Green	Brown	Green	Brown	Green	Green	Grey	Yellow	Green	Brown	Green	Green
11901 - 20" Chief Head 	-	-	-	-	✓	✓	✓	✓	✓	✓	-	✓	✓	✓	✓
11701 - 20" Tour Pro Head 	-	-	-	-	✓	✓	✓	✓	✓	✓	-	✓	✓	✓	✓
11771 - 25" Tour Pro Head 	-	-	-	-	✓	✓	✓	✓	✓	✓	-	✓	✓	✓	✓
11801 - 15" Tour Smooth II Head 	-	-	-	-	✓	✓	✓	✓	✓	✓	-	-	-	✓	✓
12202 - 22" Tour Smooth II Head 	-	-	-	-	✓	✓	✓	✓	✓	✓	-	-	-	✓	✓
11601 - 15" Economy Rake Head 	✓	✓	✓	✓	-	-	-	-	-	-	-	-	-	-	-
12301 - 15" Tour Lite/ Cart Rake Head 	✓	✓	✓	✓	-	-	-	-	-	-	-	-	-	-	-
11501 - 15" Duo-Rake Head* 	-	-	-	-	-	-	-	-	-	✓	✓	✓	✓	✓	✓

*Bolt and Cone Assembly (Part #11502) must be ordered with the Duo-Rake head to fit handle.



1 V-groove finish

2 Smooth finish

ONE RAKE TWO FINISHES

THE CHIEF BUNKER RAKE

The Chief is designed to work with the "Aussie Style" of bunker maintenance. This tine-less (toothless) rake has two sides: one smooth side to pack down the vertical sides of the bunker and another side with ridges to rough up the bottom of the bunker without leaving large grooves (plow marks) in the sand.

	GATOR GRIP HANDLE		ALUMINUM HANDLE	
	HEAD ONLY	72" (183 cm) 20" (50.8cm)	54" (137 cm) 7/8" D (2.2 cm)	60" (152 cm) 7/8" D (2.2 cm)
Green	-	11920*	11900**	11910**
Black	11901	-	-	-

*Part number 11920 ship in a box of 6.
**Part numbers 11910 & 11900 ship in box of 12.



TOUR PRO

When mediocrity isn't an option and only perfection will do, turn to Standard Golf's Tour Pro Bunker Rake. No other bunker rake can make smooth, level, playable surfaces like the Tour Pro.

- ▶ Now made from a stronger and lighter-weight material.
- ▶ 20" (51 cm) and 25" (63 cm) heads ensure tracks are covered with minimum effort, while pioneering design generates tournament quality surfaces.
- ▶ When durability is a must, the exclusive Gator Grip Handle is your best option, available in both 60" (152 cm) and 72" (183 cm) lengths.
- ▶ A single self-tapping screw (included) is all you need for assembly.



20" (51 CM) TOUR PRO

	ALUMINUM CURVED HANDLE 64" (163 cm) 3/8" D (2.2 cm)	COMPOSITE HANDLE 54" (137 cm) 3/8" D (2.2 cm)	ALUMINUM HANDLE 54" (137 cm) 3/8" D (2.2 cm)	GATOR GRIP HANDLE 60" (152 cm) 3/8" D (2.2 cm)
Green	11750*	11700	11760	11720
Brown	-	-	-	11730

Gator Grip, aluminum and composite handles are sold in multiples of twelve.
*Curved handle sold in multiples of six.

TOUR SMOOTH II

Time-tested design and performance of the Tour Smooth Bunker Rake just got an upgrade. Improved rake assembly and the addition of the exclusive Gator Grip Handle makes the Tour Smooth II a must for all courses.

- ▶ Smooths both fine and course sand into perfect playing conditions quickly and easily.
- ▶ Pair the Tour Smooth II with the exclusive 60" (152 cm) Gator Grip Handle for a level of performance unmatched by any of the competitors.
- ▶ A single self-tapping screw (included) is all you need for assembly.

25" (64 CM) TOUR PRO

	GATOR GRIP HANDLE 60" (152 cm) 3/8" D (2.2 cm)	GATOR GRIP HANDLE 72" (183 cm) 3/8" D (2.2 cm)
Green	11790	11770
Brown	-	11780

25" (64 cm) head and handles sold in multiples of six.

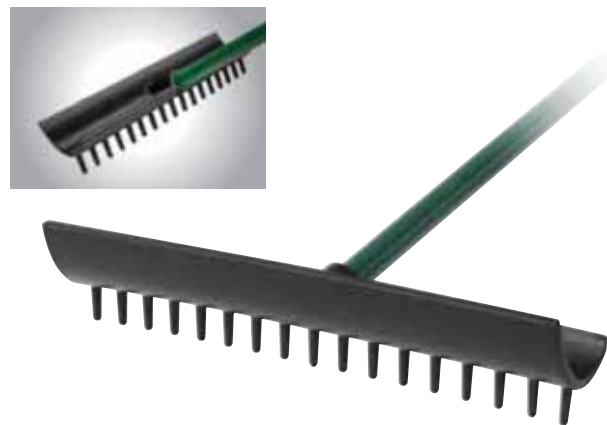

22" (56 CM) TOUR SMOOTH II

	GATOR GRIP HANDLE 60" (152 cm) 3/8" D (2.2 cm)	GATOR GRIP HANDLE 72" (183 cm) 3/8" D (2.2 cm)
Green	12210	12220

22" (56 cm) head and handles sold in multiples of six.

Gator Grip, aluminum and composite handles are sold in multiples of twelve.
*Curved handles sold in multiples of six.

CART RAKES

Convenient, economical, time-saving bunker rakes designed specifically for carts.

- ▶ Shorter 48" (122 cm) handle and 15" (38 cm) high-impact plastic head fits most golf cart bagwells.



	WOOD HANDLE 48" (122 cm) 3/8" D (2.2 cm)
Yellow	11400
Green	11425

Sold in multiples of twelve.

TOUR-LITE RAKES

Value-priced favorite of superintendents.

- ▶ Impact-resistant, 15" (38 cm) polyethylene molded head.
- ▶ Ultralight, plastic-coated steel handle.
- ▶ Redesigned neck for added strength and durability.



	ULTRALIGHT STEEL HANDLE 54" (137 cm) 3/8" D (2.2 cm)
Yellow	12350
Green	12375

Sold in multiples of twelve.

CURVED RAKE HANDLES

For Duo, Tour Smooth II and Tour Pro Rakes.

- ▶ Better visibility than traditional style handles.
- ▶ Less wear from moisture and sand.
- ▶ Less chance of damage from carts and bunker traffic.
- ▶ Packaged six per carton.



	ALUMINUM CURVED HANDLE 64" (163 cm) 3/8" D (2.2 cm)
Gold	11531
Green	11541

DUO-RAKE

One side furrows, the top side smooths and the entire rake floats!

- ▶ 15" (38 cm) high-impact plastic head.
- ▶ Now with new stronger, gusset-reinforced high-impact plastic head.
- ▶ Bolt and cone (included) is all you need for assembly.

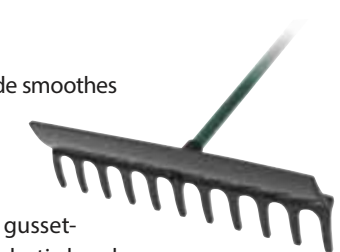

	COMPOSITE HANDLE 72" (183 cm) 3/8" D (2.2 cm)	CURVED HANDLE 64" (163 cm) 3/8" D (2.2 cm)	ALUMINUM HANDLE 54" (137 cm) 3/8" D (2.2 cm)	ALUMINUM HANDLE 54" (137 cm) 3/8" D (2.2 cm)
Natural	-	-	11500	-
Gold	-	11530*	-	-
Yellow	-	-	-	11525
Green	11545*	11540*	-	11575

Aluminum and composite handles sold in multiples of twelve.
*Curved handles and 72" composite handles sold in multiples of six.

ECONOMY RAKES

Full-size performance for smaller-sized budgets.

- ▶ Wooden or ultralight, plastic-coated steel handles.
- ▶ Tough, high-impact 15" (38 cm) molded head (and handle) are light enough to float.



	WOOD HANDLE 48" (122 cm) 3/8" D (2.2 cm)	ULTRALIGHT STEEL HANDLE 54" (137 cm) 3/8" D (2.2 cm)
Yellow	11600	11660
Green	11625	11665

Sold in multiples of twelve.

RAKE PLACEMENT DECALS

- ▶ Only available in English.
- ▶ Twelve per package.



	1" x 5 1/2" (3 cm x 14 cm)	1" x 7" (3 cm x 18 cm)
Place Rake In Bunker	11000	-
Place Rake Outside Bunker	-	11050

RANGE MATE CLUB WASHER

- ▶ Gentle, no-splash brushes will handle woods and irons.
- ▶ Efficient, effective design with replaceable brushes.
- ▶ Large-capacity, fade-resistant 9-gallon (34 L) polyethylene containers, reinforced with steel frame.
- ▶ New square opening allows easier access to clean clubs.

■ Hunter Green	01650
----------------	-------

Single Replacement Brush	01602
--------------------------	-------

Club washer requires two brushes. Priced individually.



Use with Sparkleen Liquid Detergent (see page 9).



RECYCLED CLUB WASHER

- ▶ Premier Green Line Club Washer.
- ▶ Rugged construction includes 5-gallon (19 L) bucket and hand brush.

32"H x 17"W (81 cm x 43 cm)

■ Green	200010GN
■ Brown	200010BR
■ Black	200010BK

ACE MULTI-PURPOSE CONTAINER

- ▶ 8-gallon (30 L) Club Washer, Divot Mix or Trash Container.
- ▶ Attractive side panels dress up the range or tee area.
- ▶ UV-resistant material.
- ▶ Divot Mix and Trash Container include liners and lids.
- ▶ Club Washer includes two brushes and lid.
- ▶ All-purpose container does not include brushes, lid or liner.



	ACE ALL-PURPOSE CONTAINER 16" w x 16" h x 19" d (41 cm x 41 cm x 48 cm)	ACE TRASH CONTAINER 16" w x 16" h x 19" d (41 cm x 41 cm x 48 cm)	ACE DIVOT MIX CONTAINER 16" w x 16" h x 19" d (41 cm x 41 cm x 48 cm)	ACE CLUB WASHER 16" w x 16" h x 19" d (41 cm x 41 cm x 48 cm)
■ Green	01661	12810	18910	01660
■ Brown	01671	12820	18920	01670
■ Black	01681	12830	18980	01680

Single Replacement Brush	01602
--------------------------	-------

Club Washer requires two brushes. Priced individually.



WATCH IT WORK!
StandardGolf.com

ST2000 SMART-FIT CUP

- ▶ The popular ST2000 Smart-Fit Cup has a third configuration.
- ▶ A "hybrid", with an aluminum base and plastic molded walls, combines the best of our aluminum and plastic ST2000 models.
- ▶ Notched-ferrule flagsticks fall right into place every time without twisting, sticking or sinking.
- ▶ Bonderite aluminum cups for maximum life and the most chip-resistant coating around.
- ▶ High-strength plastic cups molded with chemical-resistant polymers provide a brilliant, lasting finish.
- ▶ Meets all USGA regulations.
- ▶ U.S. Patents #5,964,667; #6,113,503 and #7,033,280B.

6" (15 cm) high 4 1/4" (10.8 cm) diameter

□ Hybrid ST2000 Cup	-	18444	-
□ Aluminum ST2000 Cup	-	-	18333
□ Pink Aluminum ST2000 Cup	-	-	18333P
□ Plastic ST2000 Cup	18222	-	-

Not compatible with grooved ferruled flagsticks.

IF IT STICKS, TWISTS OR LEANS, IT'S NOT A SMART-FIT.



Aluminum

Bonderite coated aluminum cups. The most chip-resistant coating around.

Plastic

High-strength plastic cups are molded with chemical-resistant polymers for a brilliant, lasting finish.



RIJI CUP

- ▶ Value-priced and ideal for less demanding conditions.
- ▶ Brilliant white; finished with chemical-resistant polymers.
- ▶ Meets all USGA regulations.

6" (15 cm) high 4 1/4" (10.8 cm) diameter

White Riji Cup	18200
----------------	-------



ALUMINUM CUP

- ▶ Unbeatable chip-resistant finish.
- ▶ Six "feet" on bottom of cup eliminate sinking.
- ▶ Meets all USGA / R&A regulations.

6" (15 cm) high 4 1/4" (10.8 cm) diameter

White Aluminum Cup	18303
Pink Aluminum Cup	18303P



PLASTIC PRACTICE GREEN CUP

- ▶ This cup features molded plastic construction and reinforced webs.

4" (10 cm) high 4 1/4" (10.8 cm) diameter

Plastic Practice Green Cup	18100
----------------------------	-------



ALUMINUM PRACTICE GREEN CUP

- ▶ Bonderite aluminum with the most chip-resistant coating around.
- ▶ Beveled bottom edge design makes cup easier to insert and remove.

4" (10 cm) high 4 1/4" (10.8 cm) diameter

Aluminum Practice Green Cup	18150
-----------------------------	-------



SPECIAL EVENT CUP

- ▶ Powder-coated steel cup in 6" (15.2 cm) and 8" (20.3 cm) sizes.
- ▶ Also available in pink plastic.
- ▶ Fits standard-sized flagsticks.
- ▶ Great addition for "big hole" events.
- ▶ 3" (7.6 cm) depth allows 8" (20.3 cm) cup to easily be installed with our 8" (20.3 cm) Pro II Hole Cutter.

	8" (20.3 cm) DIAMETER PLASTIC CUP 3" (8 cm) high	6" (15.2 cm) DIAMETER STEEL CUP 6" (15 cm) high	8" (20.3 cm) DIAMETER STEEL CUP 3" (8 cm) high	8" (20.3 cm) DIAMETER STEEL CUP 6" (15 cm) high
White	18775	18600	18700	18710
Pink	18775P	18600P	18700P	-

See page 92 for more pink golf accessories.

E-ZEE WHITE HOLE WHITENER SYSTEM

- ▶ Clean, crisp white holes made quick and easy!
- ▶ Simply insert paint can into tool and rotate.
- ▶ Improved formula for a brighter white tour grade finish.
- ▶ Built-in shield protects cup and green from overspray.
- ▶ Longer-lasting and better coverage.
- ▶ One-piece patented design; no assembly required.
- ▶ No purging required between uses.
- ▶ Starter kit includes tool, plus one case of paint.
(Six 15-oz (0.42 kg) cans per case.)

E-ZEE White Starter Kit	-	-	55500
E-ZEE White Tool	55600	-	-
E-ZEE White Paint (Case)	-	55700	-

WATCH IT WORK!
StandardGolf.com



FOOTGOLF CUP

- ▶ Lightweight and durable single mold construction.
- ▶ Reinforced open ribs allow dirt, sand and water to freely sift through the cup.
- ▶ No need for additional golf cup as flagstick fits into molded ferrule.
- ▶ Lid fits securely on cup to prevent debris build-up inside.

21" (53.3 cm) D 10.5" (26.7 cm) H

Lid Only	18850
Cup Only	18821
Cups and Lids (Set of 2)	18822
Cups and Lids (Set of 5)	18820



SAND GREEN CUP

- ▶ Sturdy steel construction designed for 100% sand greens.
- ▶ Remove the inner shell to empty sand.

6" (15 cm) H 4 1/4" (10.8 cm) D

Sand Green Cup	18400
----------------	-------

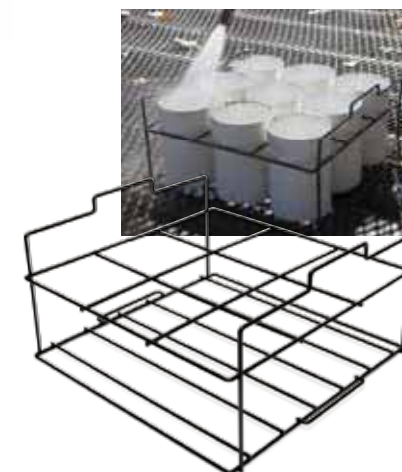

CUP CADDIE

- ▶ Handy for maintaining and rotating cups.
- ▶ Cups look better, last longer, and players notice the difference!

Cup Caddy	18990
-----------	-------

STANDARD CUP COVER

- ▶ Economical cover "fills" top of hole; doesn't damage mowers.
- ▶ Sits on top of the cup, flush with surface of the green.
- ▶ Made from synthetic polymer for a lighter and more durable construction.



NEW!

1" (2.5 cm) high 4 3/16" (10.6 cm) diameter

Green	18510
-------	-------

STANDARD HOLE REDUCER

- ▶ Sits flush on top of the cup to reduce size of cup opening by 1" (2.5 cm).
- ▶ Helps players fine-tune putting skills.
- ▶ Ideal for practice greens.
- ▶ Made from a rubber textured material that has UV stabilizers and colorfast throughout.



NEW!

1" (2.5 cm) high 4 3/16" (10.6 cm) diameter

Green	18010
-------	-------

QUAD SOIL CADDIE

- ▶ 18" (45.7 cm) long metal pole holds four soil bottle caddies.
- ▶ Caddies can hold 40 oz (1.2 L) soil bottles.
- ▶ Step on the horizontal bar and push Quad Soil Caddie into the ground.
- ▶ Perfect addition to the driving range, Par 3 or other areas where seed and soil bottles are used.
- ▶ 4-40 oz (1.2 L) bottles included.

18" (45.7 cm) long

Quad Soil Caddie	18890
------------------	-------



CUP SETTER

- ▶ Set it, step on it and lift it out.
- ▶ Sets cup to USGA-specs – 1" (2.5 cm) – below surface of the green.
- ▶ Flattens and smoothes crowning caused by hole cutters.
- ▶ Minimizes damage to the rims of aluminum cups.

Cup Setter	30100
------------	-------



RECYCLED RUBBER CUP COVER

- ▶ For low-play seasons or during top dressing.
- ▶ Economical, recycled cover "fills" top of hole; doesn't damage mowers.
- ▶ Sits on top of the cup, flush with surface of the green.

1" (2.5 cm) high 4 3/16" (10.6 cm) diameter

Rubber Cup Cover	18550
------------------	-------

Note: Use Cup Setter to ensure proper cup depth of 1" (2.5 cm).



RECYCLED HOLE REDUCER

- ▶ Ideal for practice greens.
- ▶ Helps players fine-tune putting skills.
- ▶ Sits flush on top of the cup to reduce size of cup opening by 1" (2.5 cm).

1" (2.5 cm) high 4 3/16" (10.6 cm) diameter

Rubber Hole Reducer	18000
---------------------	-------

Note: Use Cup Setter to ensure proper cup depth of 1" (2.5 cm).



POWDER-COATED CUP COVER

- ▶ Rotate cup covers instead of cups.
- ▶ Keeps holes free of top dressing material and debris.
- ▶ Lid will sit flush to green when installed properly.
- ▶ 4 1/4" (10.8 cm) cover is powder-coated steel.
- ▶ 6" (15.2 cm) and 8" (20.3 cm) covers are powder-coated aluminum.

Lip indented on bottom to fit inside cup. 6" and 8" only.

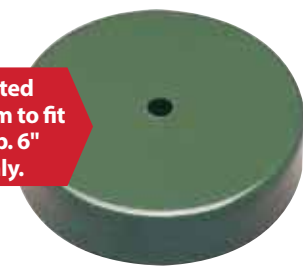

Note: Use Cup Setter to ensure proper cup depth of 1" (2.5 cm).

1" (2.5 cm) high	4 1/4" (10.8 cm) diameter	6" (15.2 cm) diameter	8" (20.3 cm) diameter
4 1/4" (10.8 cm) Cup Cover	18500	-	-
6" (15.2 cm) Cup Cover	-	18650	-
8" (20.3 cm) Cup Cover	-	-	18750

CUP HOOK

- ▶ Simple and easy way to remove any style cup.

11 1/2" (29 cm) long

Cup Hook	33200
----------	-------

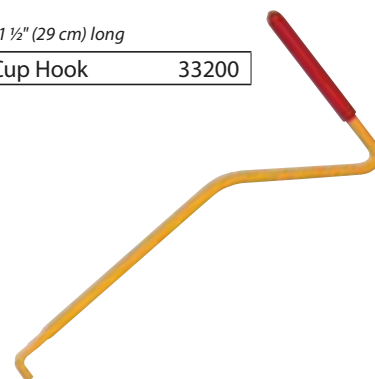

TEE SEED AND SOIL CADDIE (WITH HOLDER)

- ▶ Contoured bottle keeps mixture dry.
- ▶ Steel powder-coated holder.
- ▶ Includes decal and 78 oz (2.3 L) bottle with screw-on cap.

Black	18800
Green	18900

CART-MOUNTED SEED AND SOIL CADDIE

- ▶ Mounts to framework or basket of any golf cart –horizontally or vertically.
- ▶ Includes 40 oz (1.2 L) bottle with cap.

Black	18950
-------	-------



SEED & SOIL BOTTLE

- ▶ Contoured design keeps mixture dry, easier to dispense.
- ▶ Select 3 1/2" (8.9 cm) or 5" (12.7 cm) diameter sizes.
- ▶ 40 oz (1.2 L) bottle comes with a coned lid to fit "no spill" cart holsters.
- ▶ Rattle-proof lid.



Bottle size: 13" (34 cm) H 3 1/2" (8.9 cm) D 5" (12.7 cm) D

40-oz (1.2 L) Cart Seed and Soil Bottle with Lid	18952	-
78-oz (2.3 L) Tee Seed and Soil Bottle with Lid	-	18802

SEED & SOIL BOTTLE W/HANDLE **NEW!**

New to the line-up of seed and soil bottles is Standard Golf's 40 oz (1.2 L) bottle with handle and rattle proof lid.

40 oz (1.2 L) Seed & Soil Bottle w/Handle	18955
---	-------



MAKE IT GREEN LINE



- ▶ 100% recycled material with stainless steel hardware.
- ▶ Select any of three different colors!



ROUND DIVOT MIX BOX

- ▶ Convenient handle-style lid.
- ▶ Includes liner and 16 oz (0.5 L) scoop.
- ▶ Lid sold separately (See page 94 for lid options).

	3½-GALLON (13 L) 14 ½"H x 14"W (37 cm x 36 cm)	5-GALLON (19 L) 17 ½"H x 14 ½"W (44 cm x 37 cm)	10-GALLON (38 L) 21"H x 19"W (53 cm x 48 cm)
Green	200050GN	200060GN	200070GN
Brown	200050BR	200060BR	200070BR
Black	200050BK	200060BK	200070BK

SEED AND SOIL BUTLER

- ▶ Ideal for ranges and par 3s involving heavy iron play.
- ▶ Large 9-gallon (34 L) polyethylene container with steel frame support.
- ▶ Includes steel stand and 8 oz (0.25 L) scoop.



19" (48 cm) high 15" (38 cm) diameter

Green Granite	18970
---------------	-------

JR. SEED AND SOIL BUTLER

- ▶ Sturdy, self-standing – no need for wire stand.
- ▶ Made of strong, UV resistant polymer.
- ▶ Easily moved from location to location.
- ▶ "Green Granite" color.
- ▶ Capacity: 3 gallons (11.3 L).
- ▶ Comes with a 4 oz. (0.12 L) scoop (#18963).



JR. SEED AND SOIL BUTLER
15 ½" (39.4 cm) diameter 10 ¾" (27.3 cm) height

Green Granite	18870
---------------	-------

CUSTOMIZE YOUR GREEN LINE PRODUCTS!

- ▶ Promote your brand by adding a custom logo to your Green Line products.
- ▶ Logos are engraved with colored resin or inlaid with full-color decal.

Green Line Logo Charge	21300GL
------------------------	---------



DIVOT MIX BOX

- ▶ Hinged lid and holding strap prevent hinge damage.
- ▶ Includes 16 oz (0.5 L) scoop.

	3½-GALLON (13 L) 12 ½"H x 12"W x 12"D (32 cm x 30 cm x 30 cm)	5-GALLON (19 L) 17"H x 11"W x 9"D (43 cm x 28 cm x 23 cm)
Green	200040GN	200030GN
Brown	200040BR	200030BR
Black	200040BK	200030BK

Small



Large



Large

Small

ADD YOUR LOGO
SEE PAGE 20

BULK DIVOT MIX CONTAINER

- ▶ Large-capacity, heavy-duty containers with hinged lids.
- ▶ Clean, smart styling fits in wherever you place them.
- ▶ Small container, approx. 63 ½ gallons (240 L); large container, approximately 117 gallons (443 L).

	SMALL 24"H x 34"W x 18"D (61 cm x 86 cm x 46 cm)	LARGE 31"H x 36"W x 24"D (79 cm x 91 cm x 61 cm)
Green	200080GN	200090GN
Brown	200080BR	200090BR
Black	200080BK	200090BK

RECYCLED DIVOT MIX BOTTLE BOX

- ▶ Compact. Portable. Rugged.
- ▶ Bottle storage box holds up to twelve 40 oz (1.2 L) bottles.
- ▶ Bottles not included.

16"H x 18"W x 13"D
(41 cm x 46 cm x 33 cm)

Green	200140GN
Brown	200140BR
Black	200140BK



SCORECARD CADDIE WITH POST

Perfect for first and second tees, turns or near the clubhouse.

- ▶ Perched on 60" (152 cm) post – 4" x 4" (10 cm x 10 cm).
- ▶ "Scorecards and Pencils" tag included.

60"H x 16 ½"W x 14 ½"D
(152 cm x 42 cm x 37 cm)

Green	100180GN
Brown	100180BR
Black	100180BK



RECYCLED DIVOT MIX BOTTLE RACK

- ▶ Holds 24-40 oz (1.2 L) bottles. Comes with 4" x 4" (10 cm x 10 cm) 60" posts (152 cm) for permanent in-ground installations.
- ▶ Convenient leveling feet for placement on surfaces also available upon request for an additional charge.
- ▶ Accommodates bottles with and without handles.
- ▶ Bottles not included.

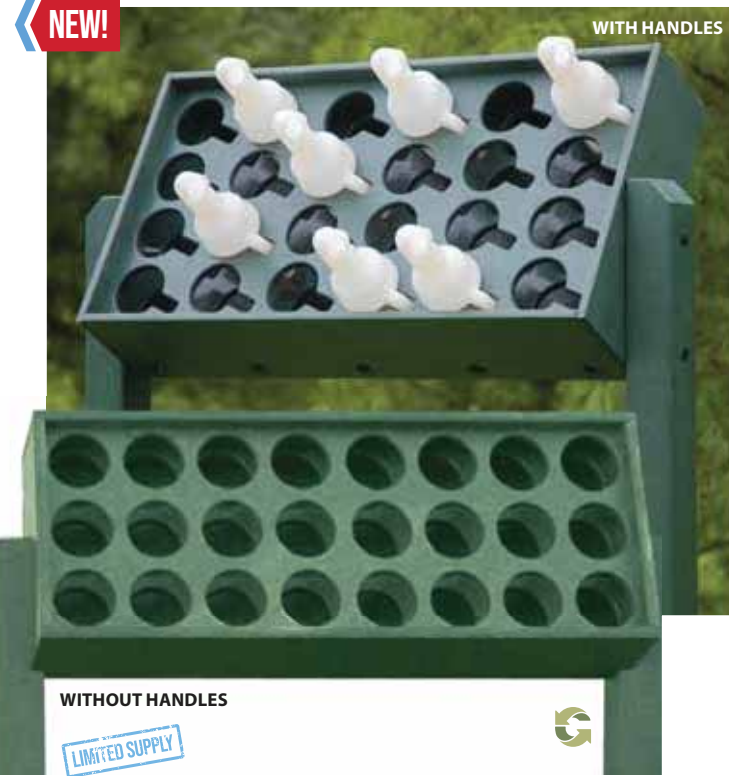

60" H x 41" W x 16" D
(152 cm x 104 cm x 41 cm)

	NO HANDLE SLOTS	SLOTS FOR HANDLE
Green	200130GN	200135GN
Brown	200130BR	200135BR
Black	200130BK	200135BK



DOUBLE DIVOT MIX BOTTLE RACK

- ▶ A must for any golf course.
- ▶ Portable design makes placement easy anywhere on your course.
- ▶ Holds 30-40 oz 1.2 L) seed and soil bottles.
- ▶ Bottles not included.

35" H x 58" W x 18" D (89 cm x 147 cm x 46 cm)

Green	200145GN
Brown	200145BR
Black	200145BK

BOTTLE STORAGE BOX

- ▶ Two models/capacities:
 - 25-40 oz (1.2 L) bottles
 - 50-40 oz (1.2 L) bottles
- ▶ Stylish heavy-built frame housing.
- ▶ Bottles not included.

	25-BOTTLE 24" H x 32" W x 24" D (61 cm x 81 cm x 61 cm)	50-BOTTLE 32" H x 45" W x 25" D (81 cm x 114 cm x 64 cm)
Green	200110GN	200120GN
Brown	200110BR	200120BR
Black	200110BK	200120BK



BACK BENCH

- ▶ Premium finish.
- ▶ Extra comfort for players during slow play.
- ▶ Full back support.
- ▶ Heavy-duty design.

	4' (1.2 m) BENCH 35" H x 48" W (89 cm x 122 cm)	6' (1.8 m) BENCH 35" H x 72" W (89 cm x 183 cm)
Green	100200GN	100300GN
Brown	100200BR	100300BR
Black	100200BK	100300BK



FLAT BENCH

- ▶ Premium finish.
- ▶ Simple. Rugged. Versatile. Maintenance-free.
- ▶ Great for tees, ranges or anywhere on the course.

	4' (1.2 m) BENCH 16" H x 48" W (41 cm x 122 cm)	6' (1.8 m) BENCH 16" H x 72" W (41 cm x 183 cm)
Green	100400GN	100500GN
Brown	100400BR	100500BR
Black	100400BK	100500BK



NEW!

ROCK ISLAND BACK BENCH

- ▶ Made from recycled plastic these benches will not warp, splinter or rot.
- ▶ No need to paint or stain.
- ▶ We offer the back bench in two sizes, 4' (1.2 m) and 6' (1.8 m) and have three colors for each: Brown, Black and Green. **Note:** the legs will always be black.

	4' (1.2 m) BENCH 16.75" (42.5 cm) depth 33" (83.8 cm) bench height	6' (1.8 m) BENCH 16.75" (42.5 cm) depth 33" (83.8 cm) bench height
Green	400200GN	400300GN
Black	400200BK	400300BK
Brown	400200BR	400300BR



NEW!

DELTA FLAT BENCH

- ▶ Made from recycled plastic these benches will not warp, splinter or rot.
- ▶ No need to paint or stain.
- ▶ We offer the flat bench in two sizes, 4' (1.2 m) and 6' (1.8 m) and have three colors for each, Brown, Black and Green. **Note:** the legs will always be black.

	4' (1.2 m) BENCH 16.75" (42.5 cm) depth 17" (43.2 cm) height	6' (1.8 m) BENCH 16.75" (42.5 cm) depth 17" (43.2 cm) height
Green	400400GN	400500GN
Black	400400BK	400500BK
Brown	400400BR	400500BR

400 DENIER VS. 200 DENIER FLAG FACTS:

FACT #1

Sometimes less is more. 400 denier is relatively new to the industry and typically used on sailboats.

FACT #2

The purpose of a golf flag is to show where the cup is and to help golfers judge wind speed. It takes a 7 to 10 mph wind to get a 400 denier flag waving. It takes a 3 to 5 mph wind to get a 200 denier flag waving. Advantage: 200 denier. Plus, the heavier 400 denier flag wears out ferrules, flagsticks and cups quicker.

FACT #3

Golf flags are meant to fly. Sails are meant to propel sailboats. One has nothing to do with the other. So trust us when we tell you the only time we recommend 400 denier is usually when we're talking to sailors, not superintendents.

All nylon flags made with DuPont SolarMax Nylon.

BEST WAY TO FLY!

Standard Golf's special quad-stitch process ensures a more durable flag that flies true in any wind. Look at the difference! Four rows of stitching instead of two, and wider edges that reduce wear.

STANDARD GOLF'S QUADRUPLE-STITCHED BORDERS

VS.

COMPETITORS' DOUBLE-STITCHED BORDERS

QUADRUPLE-STITCHED

QUADRUPLE-STITCHED

DOUBLE-STITCHED

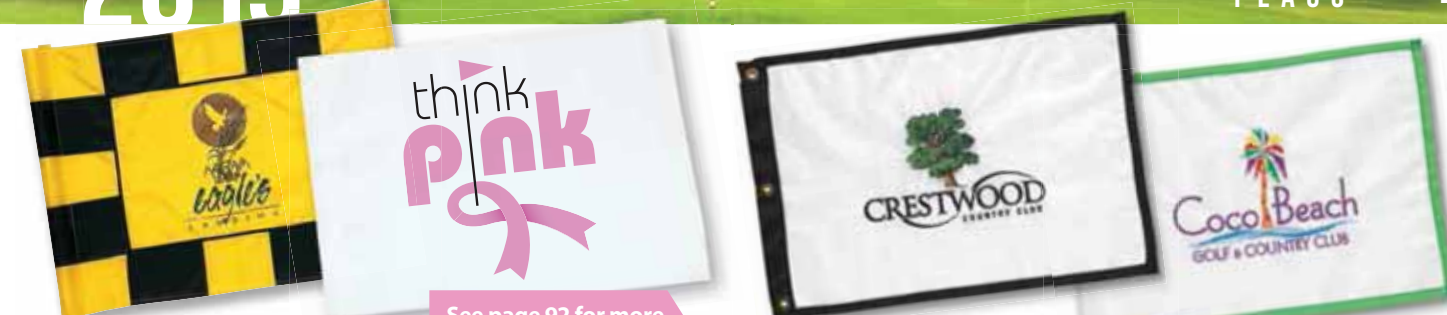

See page 92 for more pink golf accessories.

1 SCREEN PRINTING

Select your favorite color and style of flag on pages 26-27; then record the product code based on the number of colors you plan to use in your design or logo.

2 CHOOSE NUMBER OF COLORS IN YOUR LOGO

	Set of Nine
One-Color	21011
Two-Color	21021
Three-Color	21031
Four-Color	21041
Five-Color	21051
Six-Color	21061

3 ADDITIONAL OPTIONS

DOUBLE-SIDED CUSTOMIZATION

Screen print or embroider your logo to read correctly on both sides of the flag for unparalleled visibility.



Screen Printing	21375
-----------------	-------

Embroidery	Call for Specialized Quote
------------	----------------------------

Please email orders@StandardGolf.com, call SG Express at 866-743-9773 or contact your distributor for exact pricing based on the stitch count.

4 ONE-TIME ART CHARGES

FOR SCREEN PRINTING

Art charge waived on orders of four sets (36 flags) or more with same logo, or if artwork is provided in vector format.

Full Art Charge	21300
-----------------	-------

One-time charge for logos being printed for the first time.

Partial Art Charge	21310
--------------------	-------

For changes in previously printed orders and date changes.

1 EMBROIDERY

Select your favorite color and style of flag on pages 26-27; then record product code based on quantities ordered for the style selected.

2 CHOOSE FLAG QUANTITIES

	Non-Checkered Styles	Checkered Styles
12-35 Flags	21700T	21750T
36-59 Flags	21701T	21751T
60-143 Flags	21702T	21752T

Please email orders@StandardGolf.com, call SG Express at 866-743-9773 or contact your distributor for exact pricing based on the stitch count.

INDIVIDUAL NUMBERING

	Per Set of Nine
Numbers in 3" (7.6 cm) Circle	21324
Individually Screened Numbers Specify size of number 3" (7.6 cm), 4" (10.2 cm), 5" (12.7 cm) or 6" (15.2 cm) in height	21325



Up to 30,000 Stitches	21790
From 30,000 to 100,000 Stitches	21791

FOR EMBROIDERY

First time embroidery projects require digitizing of the logo. Setup charge is based on estimated stitch count.

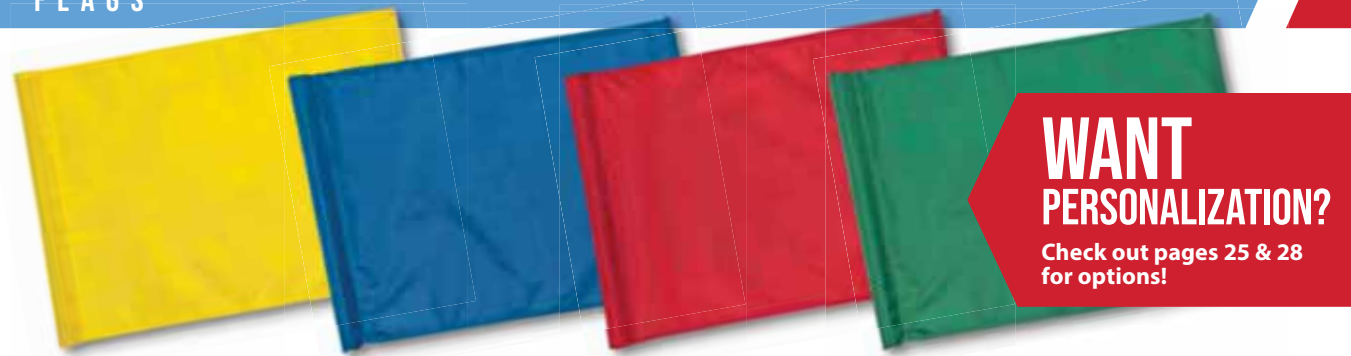

WANT PERSONALIZATION?

Check out pages 25 & 28 for options!

**PLAIN FLAG
DUPONT SOLARMAX NYLON**

200 Denier 14" x 20" (35.6 cm x 50.8 cm)	Grommets	Tube-Lock
Red	22190	22190T
White	22200	22200T
Yellow	22210	22210T
Orange	-	22220T
Dartmouth	-	22230T
Spanish Yellow	-	22240T
Medium Blue	22250	22250T
Dark Blue	22260	22260T
Green	22280	22280T
Light Blue	-	22340T
Purple	-	22350T
Maroon	-	22380T
Black	22410	22410T
Pink	22420	22420T
Gold	-	22430T
Red/White/Blue (3 each)	22460	22460T

Set of Nine

**PLAIN FLAG
DUPONT SOLARMAX NYLON**

400 Denier 14" x 20" (35.6 cm x 50.8 cm)	Tube-Lock
Red	22190TX
White	22200TX
Yellow	22210TX
Spanish Yellow	22240TX
Medium Blue	22250TX
Green	22280TX
Black	22410TX

Set of Nine

**PLAIN FLAG
HEAVY WEAVE POLYESTER**

14" x 20" (35.6 cm x 50.8 cm)	Grommets	Tube-Lock
Dark Red	23180	23180T
White	23190	23190T
Dark Blue	-	23210T

Set of Nine

**PLAIN FLAG
VENTI-KNIT**

14" x 20" (35.6 cm x 50.8 cm)	Tube-Lock
Red	24160T
White	24170T
Yellow	24180T

Set of Nine

**FULL BORDER FLAG
DUPONT SOLARMAX NYLON**

Durable, one-piece 1" (2.5 cm) border for stronger, bolder look.

200 Denier 14" x 20" (35.6 cm x 50.8 cm)	
White/Red	25400T
White/Medium Blue	25350T
White/Dark Blue	25360T
White/Green	25410T
White/Black	25310T
Yellow/Green	25340T
Yellow/Black	25330T
Red/Black	25300T
Medium Blue/Black	25320T

Set of Nine

**TWO-TONE FLAG
DUPONT SOLARMAX NYLON**

200 Denier 14" x 20" (35.6 cm x 50.8 cm)	
White/Red	22700T
White/Medium Blue	22710T
White/Green	22730T
White/Black	22750T
Yellow/Green	22770T
Yellow/Black	22780T
Red/Black	22790T
Medium Blue/Black	22800T

Set of Nine



**NUMBERED FLAG
DUPONT SOLARMAX NYLON**

200 Denier 14" x 20" (35.6 cm x 50.8 cm)	1-9	10-18	1-9	10-18	Single
White/Red	22111	22110	22111T	22110T	22112T*
White/Medium Blue	-	-	22141T	22140T	-
White/Green	-	-	22161T	22160T	-
White/Black	-	-	22181T	22180T	-
Yellow/Red	-	-	22931T	22930T	-
Yellow/Medium Blue	-	-	22941T	22940T	-
Yellow/Green	-	-	22951T	22950T	-
Yellow/Black	22121	22120	22121T	22120T	22122T*
Red/Black	-	-	22911T	22910T	-
Red/White	22101	22100	22101T	22100T	22102T*
Medium Blue/White	-	-	22151T	22150T	22152T*
Orange/Black	-	-	22131T	22130T	-
Green/White	-	-	22171T	22170T	-

Set of Nine

*Specify hole numbers by adding a hyphen (-) and hole number at end of part number. Ex: 22112T-1

**NUMBERED FLAG
HEAVY WEAVE POLYESTER**

14" x 20" (35.6 cm x 50.8 cm)	1-9	10-18
Red/White	23101T	23100T
White/Red	23111T	23110T

Set of Nine

**NUMBERED FLAGS
VENTI-KNIT**

14" x 20" (35.6 cm x 50.8 cm)	1-9	10-18
Red/White	24101T	-
White/Red	24111T	24110T
Yellow/Black	24121T	-

Set of Nine

Great technology in the tube locks for stronger flags!



**SEMAPHORE & PENNANT
DUPONT SOLARMAX NYLON**

Dual numbered flags are ideal for nine-hole courses.

200 Denier Semaphore 14" x 20" (35.6 cm x 50.8 cm)	Tube-Lock
Red/White	22300T
Black/White	22400T
Med Blue/White	22450T
Green/White	22470T
Black/Yellow	22480T

Set of Nine

Dual Numbered Semaphore (1-10 through 9-18) 14" x 20" (35.6 cm x 50.8 cm)	Tube-Lock
Red/White	22310T

Set of Nine

Pennant	Tube-Lock
White/Red	22290T

Set of Nine

**SEWN CHECKERED FLAG
DUPONT SOLARMAX NYLON**

Finish it off with your club logo inside our open-center design.

200 Denier 14" x 20" (35.6 cm x 50.8 cm)	Checked	Open-Center
Red/White	22630T	22630TP
Med Blue/White	22640T	22640TP
Green/White	22650T	22650TP
Dartmouth/White	22680T	22680TP
Yellow/White	22660T	22660TP
Black/White	22330T	22330TP
Black/Red	22610T	22610TP
Black/Med Blue	22620T	22620TP
Black/Yellow	22320T	22320TP
Red/Yellow	22690T	-
Med Blue/Yellow	22670T	22670TP
Dartmouth/Yellow	22590T	-
Pink/White	22570T	-

Set of Nine



See page 92 for more pink golf accessories.

DESIGN YOUR OWN FLAGS

CUSTOMIZED FLAGS

- ▶ Full coverage graphics available!
- ▶ Revolutionary, state-of-the-art dye sublimation process.
- ▶ Full-color printing capabilities create photo-quality logo reproduction.
- ▶ More versatile and economical when compared to traditional screen printed or embroidery processes.
- ▶ Maximum UV-resistant material helps maintain long-lasting color.
- ▶ Exclusive quadruple-stitched edges extend flag life.
- ▶ Your choice of two fabrics – heavy-weave polyester for the feel of cotton or the nylon-like feel of the 200 denier tight-weave polyester material.



14" x 20" (35.6 cm x 50.8 cm)	Grommets Single	Grommets Set of Nine	Tube-Lock Single	Tube-Lock Set of Nine
Customized 200 Denier Polyester	25752	25750	25752T	25750T
Customized Heavy-Weave Polyester	25852*	25850*	25852T*	25850T*

Minimum order of nine. Each flag design can be individually customized.

FULL COVERAGE FLAGS

- ▶ Golf flags like you have never seen them before! Any color and any pattern!
- ▶ Photo-quality color flags with mirror image printing.
- ▶ Only available with 200 Denier Polyester and event flags.



▲ Full vibrant color on both sides.



▲ Image is mirrored on the back.

14" x 20" (35.6 cm x 50.8 cm)	Grommets Single	Grommets Set of Nine	Tube-Lock Single	Tube-Lock Set of Nine
Full Coverage Customized 200 Denier Polyester*	25752F	25750F	25752TF	25750TF

Minimum order of nine. Each flag design can be individually customized. *Heavy-weave is not available for full coverage flags. Art charges may apply.

NO FLAG PROOFS PROVIDED BEFORE THE ORDER HAS BEEN PLACED.

DOUBLE-SIDED DYE-SUB FLAG

NEW!

- ▶ Read flags from both sides with double-sided images.
- ▶ Combine images to make flag appear as two different flags – club logo on one side, tournament logo on the other.
- ▶ Construction includes liner between layers to limit "image show through".

14" x 20" (35.6 cm x 50.8 cm)	Single	Set of Nine
Full Coverage Double-Sided Dye-Sub Flag (Tube-Lock)	25802T	25800T
Full Coverage Double-Sided Dye-Sub Flag (Grommets)	25802	25800

Minimum order of nine. Each flag design can be individually customized. Art charges may apply.



CLUB FLAG

NEW!

- ▶ Match your on-course pin flags with a flag for your club!
- ▶ Roughly 3' x 5' (0.91 m x 1.52 m) these flags are big and will be seen – perfect to fly on your club's flagpole, hang near scorer's table or even in your maintenance shop.
- ▶ Polyester flag material with sewn-in grommets.
- ▶ Quad stitching throughout flag.

	SINGLE 3'H x 5'W (91 cm x 152 cm)	SINGLE 4'H x 6'W (122 cm x 183 cm)
Full Coverage Customized Club Flag	25835	25846

EVENT FLAGS POLYESTER

- ▶ Rich, full color, photo-quality reproduction.
- ▶ Every flag can be customized at no additional cost!
- ▶ Simply email your artwork to orders@StandardGolf.com to see if you qualify for FREE artwork setup; better yet give us a call at 1-866-743-9773.
- ▶ Economical. Versatile. Vibrant.
- ▶ Cloth tube design lays flat; ideal for framing.
- ▶ Available on white polyester only.
- ▶ Designed for use in events. Limited 30-day warranty.



**IF YOU CAN DESIGN IT,
WE CAN PRODUCE IT.**

14" x 20" (35.6 cm x 50.8 cm)	Single	Single	Set of Nine	Set of Nine
Customized Event Flag	25652	–	25650	–
Full Coverage Customized Event Flag	–	25652F	–	25650F

Minimum order of nine. Each event flag design can be individually customized. Art charges may apply.

NO FLAG PROOFS PROVIDED BEFORE THE ORDER HAS BEEN PLACED.

PLAIN PRACTICE GREEN FLAG

- ▶ Now available in 1/2" (1.3 cm) size to fit Junior Tournament practice green rods and Par Aide practice green rods.
- ▶ Customize with your logo (see below).
- ▶ Made with DuPont SolarMax nylon.

5 1/2" x 8" (13.9 cm x 20.3 cm)	SMALL TUBE Fits 3/8" (1 cm) Rod	LARGE TUBE Fits 1/2" (1.3 cm) Rod
Green	20594	20596
Red	20694	20696
White	20794	20796
Yellow	20894	20896
Blue	20994	20996
Orange	20494	20496
Black	20394	20396
Single Flag	\$4.00	\$4.50



CUSTOMIZED PRACTICE GREEN FLAG

- ▶ Revolutionary, state-of-the-art dye sublimation process.
- ▶ Full-color printing capabilities create photo-quality logo reproduction.
- ▶ Maximum UV-resistant material helps maintain long-lasting color.
- ▶ More versatile and economical when compared to traditional screen printed or embroidery processes.
- ▶ Available in 3/8" (1 cm) and 1/2" (1.3 cm) sizes to fit Standard Golf and Par Aide practice green rods.
- ▶ **Minimum order of nine required for customized flags.**



5 1/2" x 8" (13.9 cm x 20.3 cm)	SMALL TUBE SINGLE Fits 3/8" (1 cm) Rod	SMALL TUBE SET OF NINE Fits 3/8" (1 cm) Rod	LARGE TUBE SINGLE Fits 1/2" (1.3 cm) Rod	LARGE TUBE SET OF NINE Fits 1/2" (1.3 cm) Rod
Customized 200 Denier Practice Green	25902	25900	25952	25950
Full Coverage Customized 200 Denier Polyester	25902F	25900F	25952F	25950F

Minimum order of nine. Each flag design can be individually customized. Art charges may apply.

CHECKERED PRACTICE GREEN FLAG

- ▶ For a classier, more distinctive look.
- ▶ Now available in 1/2" (1.3 cm) size to fit Junior Tournament practice green rods and Par Aide practice green rods.
- ▶ Made with DuPont SolarMax nylon.
- ▶ Available in both sewn and anco-printed styles.



5 1/2" x 8" (13.9 cm x 20.3 cm)	ANCO-PRINT SMALL TUBE Fits 3/8" (1 cm) Rod	ANCO-PRINT LARGE TUBE Fits 1/2" (1.3 cm) Rod	SEWN SMALL TUBE Fits 3/8" (1 cm) Rod	SEWN LARGE TUBE Fits 1/2" (1.3 cm) Rod
Black/White	20912	20917	21912	21917
Red/White	20922	20927	21922	21927
Black/Yellow	20932	20937	21932	21937
Green/White	20942	20947	21942	21947

Single Flag

EMBROIDERED PRACTICE GREEN FLAGS

- ▶ The elegance of embroidery with UV-resistant, color-fast threads for lasting brightness.
- ▶ Includes set of nine plain practice green flags.



5 1/2" x 8" (13.9 cm x 20.3 cm)	Set of Nine
Logo Tape Set-up Charge	20990
Up to 8,000 Stitches	20950
Over 8,000 Stitches	Email orders@StandardGolf.com for quote



5 1/2" x 8" (13.9 cm x 20.3 cm)	SMALL TUBE SINGLE Fits 3/8" (1 cm) Rod	SMALL TUBE SET OF NINE Fits 3/8" (1 cm) Rod	LARGE TUBE SINGLE Fits 1/2" (1.3 cm) Rod	LARGE TUBE SET OF NINE Fits 1/2" (1.3 cm) Rod
Customized 200 Denier Practice Green	25902	25900	25952	25950
Full Coverage Customized 200 Denier Polyester	25902F	25900F	25952F	25950F

Minimum order of nine. Each flag design can be individually customized. Art charges may apply.

SCREEN PRINTED PRACTICE GREEN FLAG CHARGES

- ▶ From one color to seven colors. Available on plain flags only.
- ▶ Prices shown do not include base flag cost (see above).



5 1/2" x 8" (13.9 cm x 20.3 cm)	Set of Nine
One-Color	20901
Two-Color	20902
Three-Color	20903
Four-Color	20904
Five-Color	20905
Six-Color	20906

Minimum order of nine.

PLACEMENT FLAGS

- ▶ Slide up or down to indicate hole position. And remind players to "Please Repair Ball Marks" (English only).
- ▶ Placement Flags fit flagsticks up to 3/4" (1.9 cm) diameter.
- ▶ Rubber grommets included.
- ▶ Made with DuPont SolarMax nylon.



	PLAIN (NO MESSAGE)		PLEASE REPAIR BALL MARKS	
	1/2" (1.3 cm) flagstick	3/4" (1.9 cm) flagstick	1/2" (1.3 cm) flagstick	3/4" (1.9 cm) flagstick
Red	05345	05347	05335	05337
Yellow	05365	05367	05355	05357
White	05371	05372	-	-

Set of Nine

Note: Personalized placement flags also available.

SWIVEL

- ▶ For easy flag changing, use our handy Snap-Lock swivel.

Snap-Lock Swivel	26322
------------------	-------

Not included with flagsticks. Must be ordered separately.

Snap-Lock



BUDGET FLAGS

- ▶ Ideal for temporary greens, early/late-season flags and tight budgets.
- ▶ Cloth tube design makes installation easy.
- ▶ Limited 30-day warranty.
- ▶ Personalization not available.
- ▶ 100% polyester.

	Single	Set of Nine
White	25602	25600
Red	25612	25610
Yellow	25622	25620
Blue	25632	25630

EVENT SPIKE

- ▶ The perfect spot to place the flagstick while on the green so that the American or other event flag does not touch the ground.

20" x 10" (51 cm x 25.4 cm)

Event Spike	26720
-------------	-------



PLACEMENT MARKER

- ▶ Placement Markers fit flagsticks 1/2" (1.3 cm) diameter only.
- ▶ Rubber grommets included.

Red	05350
White	05351
Blue	05352
Yellow	05353



RUBBER GROMMETS

1/2" (1.3 cm) Flagstick	05354
3/4" (1.9 cm) Flagstick	05360



AMERICAN FLAG

- ▶ Rugged two-ply polyester American flags.
- ▶ Four sizes for clubhouse and grounds.



	Single
3'H x 5'W (91 cm x 152 cm)	21900
4'H x 6'W (122 cm x 183 cm)	21901
5'H x 8'W (152 cm x 244 cm)	21902
6'H x 10'W (183 cm x 305 cm)	21903

AMERICAN AND CANADIAN GOLF FLAGS

- ▶ Put your nation's flag on display during the next holiday.
- ▶ For practice greens, please order rods, knobs and bases separately.
- ▶ American flag is anco-dyed.
- ▶ Canadian flag is screen-printed.



20" x 14" (51 cm x 36 cm)	Set of Nine
American Flag Replica – For Flagstick	22466T
Canadian Flag Replica – For Flagstick	25500T

5 1/2" x 8" (14 cm x 20 cm)

	Single
American Flag Replica – For 3/8" (1.0 cm) rods	20987
American Flag Replica – For 1/2" (1.3 cm) rods	20787



WATCH IT WORK!
StandardGolf.com

IF IT STICKS, TWISTS OR LEANS IT'S TIME TO SWITCH!

- ▶ Patented solution for pre-mature wear.
- ▶ Notched-ferrule flagsticks fall right into place every time.
- ▶ Sturdy, gusset-reinforced ribs allow dirt and sand to freely sift through the cup to eliminate sticking.

*See page 15 for more information on ST2000 Cups.

SMART-FIT PRO FERRULE

- ▶ 16 tapered flanges seat the ferrule and flagstick perfectly with the Smart-Fit Cup ... EVERY TIME.
- ▶ Comes standard on all flagstick orders and works great on all styles of cups.
- ▶ To help prevent chipping cups or dulling the Smart-Fit finish, our Smart-Fit Pro Ferrules have a polymer base. This base will help increase the life of your cups!

Smart-Fit Pro Ferrule 26512

Smart-Fit Pro Ferrule



Traditional Ferrule

TRADITIONAL FERRULE

Traditional Ferrule 26517

PUTT-SAVER TOURNAMENT FLAGSTICK

COMING SPRING 2019!



Beginning in January 2019, both the USGA and R&A have changed the rules of golf to allow a player to leave the flagstick in the hole while putting from the green. This new rule will help speed up play, but with Standard Golf's "Putt-Saver" Technology may also help you drain a few more putts.

The Putt-Saver Technology is a precisely tapered flagstick angled to direct your ball into the cup.

In addition to the Putt-Saver Technology, this new flagstick will also come in two pieces – saving costs when shipping. With a reinforced steel rod and color fully-absorbed throughout the flagstick, this is the new leader in the clubhouse.



7 1/2" (2.3 m) height

White	26350	-
Yellow	26360	-
White/Black	-	26370
White/Red	-	26380
Yellow/Black	-	26390

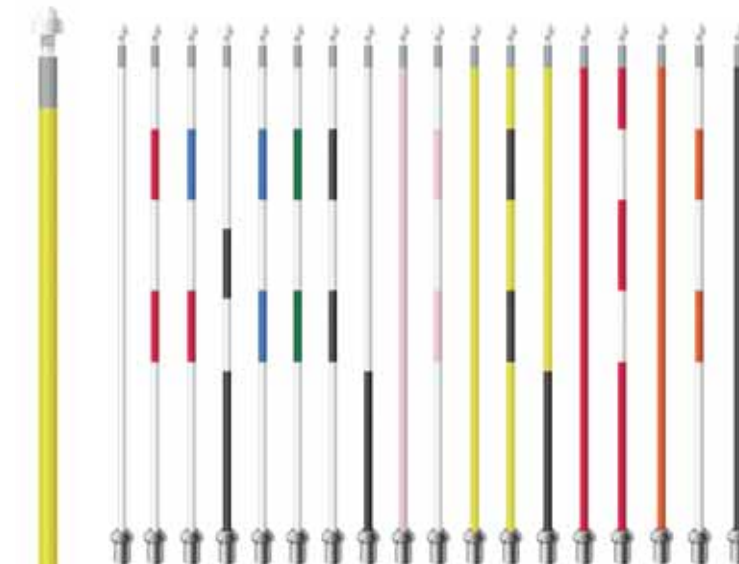

ROYALINE FLAGSTICKS

Our most popular, economical flagstick for years ... and the favorite of golf courses everywhere.

- ▶ Ultra-strong, resilient, solid fiberglass construction.
- ▶ Now with veil-wrapped protection to protect the color of the flagstick (reduce fading) and prevent splintering.
- ▶ All flagsticks come standard with the Smart-Fit Pro Ferrule.

1/2" (1.3 cm) diameter from top to bottom.

	5' (1.5 m)	5' (1.5 m)	7 1/2' (2.3 m)	7 1/2' (2.3 m)	7 1/2' (2.3 m)
White	26995	-	26100	-	-
White/Red Stripe	-	26915	-	26101	-
White/Blue/Red Stripe	-	-	-	26102	-
White/Black British Stripe	-	-	-	26103	-
White/Blue Stripe	-	-	-	26104	-
White/Green Stripe	-	-	-	26105	-
White/Black Stripe	-	-	-	26133	-
White/30" (76 cm) Black Bottom	-	-	-	26106	-
Pink	-	-	-	-	26107
White/Pink Stripe	-	-	-	26108	-
Yellow	-	-	26110	-	-
Yellow/Black Stripe	-	-	-	26111	-
Yellow/30" (76 cm) Black Bottom	-	-	-	26112	-
Red	-	-	26120	-	-
Red/White Stripe	-	-	-	26121	-
Orange	-	-	-	-	26114
White/Orange Stripe	-	-	-	26115	-
Black	-	-	26130	-	-

	8' (2.4 m)	10' (3 m)	10' (3 m)
White/Red Stripe	-	-	26910*
Yellow/Black Stripe	-	-	26911*
White	26998*	26990*	-
Yellow	26988*	26980*	-

*Freight surcharge applies to 8' and 10' flagsticks.

NOW WITH VEIL-WRAP COATING!

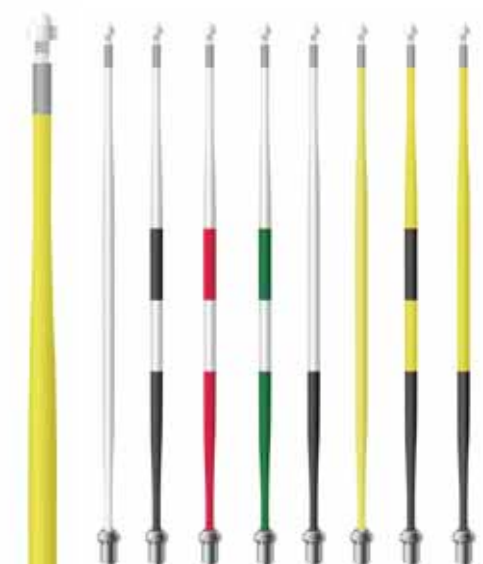

TOURNAMENT FLAGSTICKS

- ▶ Take advantage of the remarkable strength, visibility and wind resistance of the Tournament Flagstick.
- ▶ Extra heft in the center for added performance on greens.
- ▶ All flagsticks come standard with the Smart-Fit Pro ferrule.

1/2" (1.3 cm) diameter at both tip and ferrule; 3/4" (1.9 cm) diameter at the center.

	7 1/2' (2.3 m)	7 1/2' (2.3 m)
White	26300	-
White/Black British Stripe	-	26301
White/Red British Stripe	-	26302
White/Green British Stripe	-	26303
White/30" (76 cm) Black Bottom	-	26304
Yellow	26310	-
Yellow/Black British Stripe	-	26311
Yellow/30" (76 cm) Black Bottom	-	26314





FLAGSTICK CADDIE

- ▶ Keep up to 18 flagsticks free of nicks, dings and other damage during transport.
- ▶ Solid steel, powder-coated caddy with cushioned foam slots to grip and protect flagsticks.
- ▶ Vertical arm slips into stake-hole pocket of most golf utility vehicles (alternative brackets available); removes quickly and easily when not in use.
- ▶ Junior Flagstick Caddy holds up to six flagsticks.
- ▶ Caddies are recommended to use with only the 1/2 inch diameter flagsticks.

Replacement Flagstick Holder	25002
Alternative Bracket (Two Pieces)	25001
Junior Flagstick Caddy (Two Pieces)	25100
Flagstick Caddy (Two Pieces)	25000



EASYMARK SYSTEM

- ▶ Put a flagstick anywhere, without cutting a cup hole.
- ▶ EasyMark for 1/2" (1.3 cm) non-ferruled rod (cannot accept flag).
- ▶ EasyMark II for ferruled flagsticks (can accept flags).
- ▶ Versatile tap-in anchor makes it easy to set up flags for special events or on the range.

EasyMark 6" (15 cm) long 3" (7.6 cm) diameter
Rod 5' (152 cm) high 1/2" (1.3 cm) diameter

EasyMark II*	26760
EasyMark	26755
EasyMark with Rod**	26750

*Can accept regular flagsticks with ferrule.
**Rod cannot accept flag.



LASER REFLECTOR

- ▶ Easily replaces acorn nut on Standard, Par Aide, and all other flagsticks with 3/8-24 threaded tip.
- ▶ Features nylon threads. No more metal-on-metal seizing associated with brass inserts.
- ▶ Five-glass prism pod design maximizes reflectivity, leaving no dead spots.
- ▶ Prisms snap into place for extra durability.

1 1/8"H x 7/8"W (4.3 cm x 2.2 cm)

Laser Reflector	26600
-----------------	-------



The Laser Reflector screws easily onto the tip of a flagstick, replacing the acorn nut.

FLAGSTICK STAND

- ▶ Perfect for displaying flagsticks indoors.
- ▶ Powder-coated steel for increased durability.
- ▶ Stand can be mounted for temporary or permanent use.

2 1/4"H x 7 1/2" diameter (6 cm x 19.1 cm)

Flagstick Stand	26800
-----------------	-------



OFFICIAL FOOTGOLF EQUIPMENT

ROYALINE FLAGSTICK

- ▶ Choice of solid orange or striped white and orange.
- ▶ Standard Golf's most popular, economical flagstick for years, and the favorite of golf courses everywhere.
- ▶ Ultra-strong, resilient, solid fiberglass construction.



1/2" (1.3 cm) diameter from top to bottom. 7 1/2' (2.3 m) 7 1/2' (2.3 m)

Orange	-	26114
White/Orange Stripe	26115	-

PERSONALIZED DIMPLE-T MARKER

- ▶ Decals priced separately.
- ▶ 5" (12.7 cm) diameter; Decal has a 3" (7.6 cm) diameter.
- ▶ See page 49 for decal information.



PERSONALIZED DIMPLE-T MARKER
5" (12.7 cm) diameter Decal: 3" (7.6 cm) diameter

Orange	05278
--------	-------

4 1/2" (11 cm) spike

TEE BOX LITTER CADDIE LINER

- ▶ An economical way to add tee box signage and a Litter Caddy.
- ▶ Include hole number, par and yardage.
- ▶ White or orange numbers and letters.
- ▶ Fits in any 9-gallon (34 L) Litter Caddy.
- ▶ Sold in sets of three.



TEE BOX LITTER CADDIE LINER
9-gallon (34 L)

White Text	13810
Orange Text	13820

Sold in sets of three.

DIRECTIONAL STAKES

- ▶ 6 1/4" (15.9 cm) white recycled plastic stakes with a 4" orange vinyl cap.
- ▶ 5 3/4" (14.6 cm) coated steel spike.
- ▶ Round 1 1/2" (3.8 cm) diameter.
- ▶ Sold in quantities of 25 and includes black carrying bucket.



6 1/4" (15.9 cm) long, plus 5 3/4" (14.6 cm) spike

Orange	16945
--------	-------

DIRECTIONAL ARROW

- ▶ Can be all orange or include a customized decal for additional cost.
- ▶ Each sign includes two 9 1/2" (24.1 cm) galvanized screw-in stakes.



ORANGE 11"H x 2 3/4"W (28 cm x 6 cm)
ORANGE 11"H x 2 3/4"W (28 cm x 6 cm)

Arrow Sign with FootGolf Decal	10188	-
Arrow Sign Blank	-	10109



FOOTGOLF CUP

- ▶ Lightweight and durable single mold construction.
- ▶ No need for additional golf cup as flagstick fits into molded ferrule.
- ▶ Lid fits securely on cup to prevent debris build-up inside.
- ▶ A footgolf support stand comes with each cup.

21" (53.3 cm) diameter 10.5" (26.7 cm) high

Lid Only	18850
Cup Only	18821
Cups and Lids (Set of 2)	18822
Cups and Lids (Set of 5)	18820



DIRECTIONAL STAKES

- ▶ Markers used to direct golfers around sensitive areas.
- ▶ 6 1/4" (15.9 cm) white recycled plastic stakes with a 4" (10 cm) green, blue, red or yellow vinyl cap.
- ▶ 5 3/4" (14.6 cm) coated steel spike.
- ▶ Round 1 1/2" (3.8 cm) diameter.
- ▶ **Sold in quantity of 25, includes a black carrying bucket.**



6 1/4" (15.9 cm) long, plus 5 3/4" (14.6 cm) spike

Yellow	16925
Green	16935
Orange	16945
Red	16950
Blue	16975



FORCE-FLEX HAZARD/YARDAGE MARKERS

- ▶ Flexible hazard/yardage marker.
- ▶ One piece, no sleeve or cap to replace.
- ▶ Drive over with carts and mowers in any direction and the Force-Flex will bounce back up every time.
- ▶ UV-resistant rod will not fade in the sun.
- ▶ **Do not use without a ground anchor.**
- ▶ Ground anchor sold separately.
- ▶ Works best with reel deck mowers.



19" (48 cm) long, plus 7" (18 cm) spike

	Single	Set of Twelve
White	15601	15600
Yellow	15701	15700
Red	15801	15800
Blue	15901	15900

FORCE-FLEX GROUND ANCHOR

- ▶ For proper installation the ground anchor should be recessed 1/4" (32 mm) below the ground surface.



7 5/8" (19 cm) long

Ground Anchor	15500
---------------	-------

PREMIUM GREEN LINE HAZARD STAKES

- ▶ Premium recycled plastic stakes feature a decorative traditional top and rich, vibrant UV-resistant colors.
- ▶ 5 1/2" (14 cm) zinc coated hardened steel spike makes it easy for players to remove and replace.
- ▶ Purple stakes used to designate reclaimed/recycled water.
- ▶ Both sizes are 1 1/2" (3.8 cm) square.
- ▶ **Sold in sets of twelve.**

5 1/2" (14 cm) spike

	18" (46 cm) SQUARE with spike	24" (61 cm) SQUARE with spike
White	17018	17024
Yellow	17118	17124
Red	17218	17224
Blue	17318	17324



RECYCLED PLASTIC HAZARD MARKERS - WITH SPIKES

- ▶ Molded with UV-resistant colors; won't crack, rot or absorb moisture.
- ▶ 5" (13 cm) steel spike makes it easy for players to remove and replace.
- ▶ **Sold in multiples of twelve.**

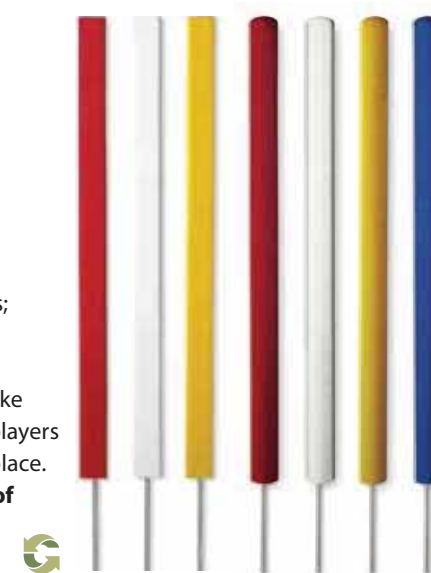

5" (13 cm) spike

Round: 1 1/2" (3.8 cm) diameter

	24" (61 cm) SQUARE with spike	24" (61 cm) ROUND with spike
White	16400	16600
Yellow	16425	16625
Red	16450	16650
Blue	-	16675

PVC HAZARD MARKERS - WITH SPIKES

- ▶ Economical. Virtually unbreakable.
- ▶ Includes end cap and 4 1/2" (11 cm) steel spike.
- ▶ **Sold in multiples of twelve.**

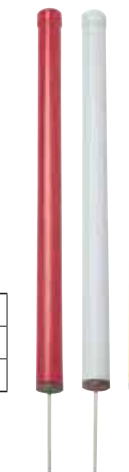

4 1/2" (11 cm) spike

Round: 1 1/2" (3.8 cm) diameter

	25" (61 cm) ROUND with spike
White	16200
Yellow	16225
Red	16250

RECYCLED PLASTIC HAZARD MARKERS - REMOVABLE

- ▶ Secure in a fixed position with PVC ground anchors (sold separately).
- ▶ Ideal for more permanent placements; easily remove when needed.
- ▶ Molded with UV-resistant colors; won't crack, rot or absorb moisture.
- ▶ **Sold in multiples of twelve.**



Round: 1 1/2" (3.8 cm) diameter

32" (81 cm) ROUND

White	16700
Yellow	16725
Red	16750
Blue	16775

PVC HAZARD MARKERS - REMOVABLE

- ▶ Remove and mow right over ground anchor (sold separately).
- ▶ Virtually unbreakable. UV-resistant colors.
- ▶ Includes end caps.
- ▶ **Sold in multiples of twelve.**



Round: 1 1/2" (3.8 cm) diameter

32" (81 cm) ROUND without spike

White	16101
Yellow	16126
Red	16151

Order ground anchors and driving tools separately from markers.

GREEN END CAPS

- ▶ Indicate environmentally-sensitive hazards by replacing regular caps on PVC markers.



Green Cap for PVC Hazard Markers	16153
----------------------------------	-------

PVC GROUND ANCHORS

Round: 7" (18 cm) long, Inside diameter: 1.59" (4.06 cm)

Square: 4" (10 cm) long Inside dimensions: 1.61" x 1.61" (4.09 cm x 4.09 cm)

Round	16157
Square	16575



DRIVING TOOL

48" (122 cm) long

Round	16158
-------	-------



MAGNUM HOLE CUTTER

- ▶ Comes with Diamond Laser Cut Hole Shells.
- ▶ Year-after-year our most popular model.
- ▶ Field-tested and proven in all soils ... with flying colors.
- ▶ Smooth lever action.
- ▶ Full selection of cutter shells to match your conditions.

4 1/4" (10.8 cm) diameter

Straight Shell sharpened inside	28960
Scalloped Shell sharpened inside	28970
Scalloped Shell sharpened outside	28980



PRO II HOLE CUTTER

- ▶ Comes with Diamond Laser Cut Hole Shells.
- ▶ Simple, economical and ready to cut.
- ▶ Cold-rolled tubing. Carbon steel shaft.
- ▶ Adjustable depth collar. Foot ejector.

4 1/4" (10.8 cm) diameter

Straight Shell sharpened inside	28700
Scalloped Shell sharpened inside	28800
Scalloped Shell sharpened outside	28801

6" (15.2 cm) diameter

Straight Shell sharpened inside	28775
------------------------------------	-------

8" (20.3 cm) diameter 3" (7.62 cm) depth

Straight Shell sharpened inside	28785
------------------------------------	-------

See page 44 for photo

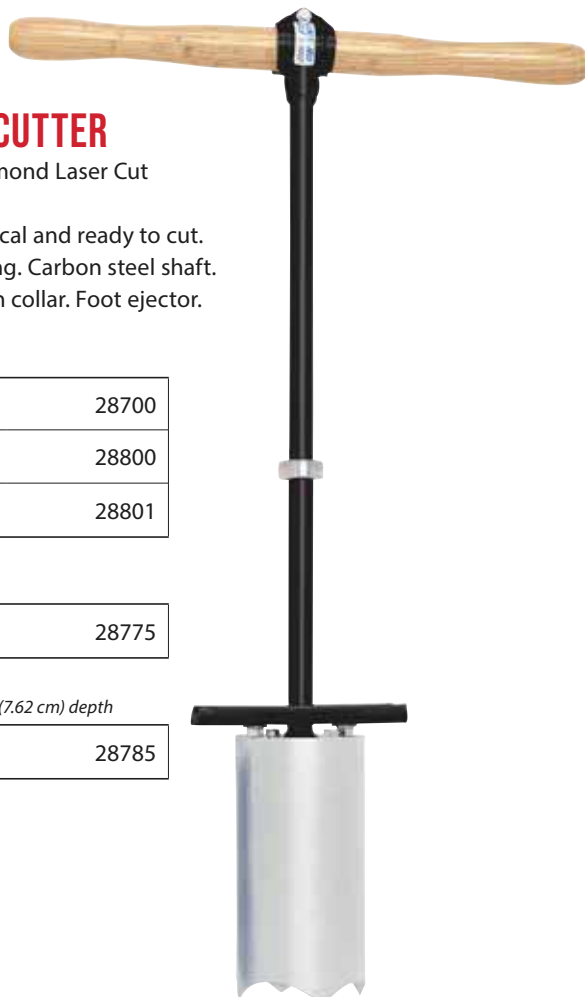

DIAMOND LASER CUT REPLACEMENT SHELL

- ▶ Laser cut to the thinnest and sharpest possible point.
- ▶ Shell easily cuts a precise hole.
- ▶ Cold rolled metal doubles the tensile and yield strength to give shell a longer and more effective life.
- ▶ Fits Magnum and Pro II Hole Cutter as well as Par Aide hole cutters.

4 1/4" (10.8 cm) diameter

Straight Shell sharpened inside	28927
Scalloped Shell sharpened inside	28952
Scalloped Shell sharpened outside	28953
Scalloped Shell (for side-mounted hole cutters)	28990



6" (15.2 cm) diameter Pro II Only

Straight Shell sharpened inside	28777
------------------------------------	-------

8" (20.3 cm) diameter Pro II Only
3" (7.62 cm) depth

Straight Shell sharpened inside	28787
------------------------------------	-------

See page 44 for photo.

TIP Standard Golf recommends inside sharpened cutting blades primarily for sand greens. They pack the sand tighter and hold it more firmly in place.

Trouble disengaging plugs? Spend just a few minutes sanding the inside of the blade with emery paper. You'll be amazed at how much easier it is to unplug.

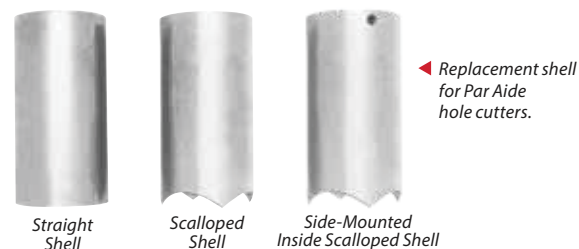

◀ Replacement shell for Par Aide hole cutters.

HOLE CUTTER GUIDE

- ▶ Get precision-cut holes every time ... with less stress on turf from twisting feet and aggressive cutting action.
- ▶ Rugged, lightweight, powder-coated aluminum base ... the ideal platform for safe, efficient cuts.



Hole Cutter Guide	28500
-------------------	-------



TURFMASTER HOLE CUTTER

- ▶ Razor-sharp outside sharpened blades prevent soil compaction and minimize impact on the putting surfaces and fragile root systems.
- ▶ Use rubber mallet to drive in the blade halves.

4 1/4" (10.8 cm) diameter 2 blades per unit.

Turfmaster Hole Cutter	28000
Rubber Mallet	28102
Replacement Blade (Two required per unit)	28002



HOLEMASTER HOLE CUTTER

Cutting into hard soil greens? Make it cleaner and easier.

- ▶ Durable, outside sharpened case-hardened blades reinforced with webs and backing plates.
- ▶ Side pins lock in shell for easy extraction, rubber mallet drives blade halves home.
- ▶ U.S. Patent #7,188,113. Foreign patent pending.

4 1/4" (10.8 cm) diameter 2 blades per unit.

Holemaster Hole Cutter	28350
Rubber Mallet	28102
Replacement Blade (Two required per unit)	28352



SHARPENER

- ▶ Keep shells sharp for easier cuts and precision-cut hole edges.
- ▶ Works with scalloped or straight cutter styles – inside or outside.

Sharpener	28400
-----------	-------



DEPTH GAUGE

- ▶ Ensure consistent, accurate cuts with Magnum or Pro II Hole Cutters.

Fits 4 1/4" (11 cm) shells

Depth Gauge	28600
-------------	-------



THE MAGNUM LINE

EXCLUSIVELY FROM STANDARD GOLF



MAGNUM MAINTENANCE RAKE (STRAIGHT TOOTH)

- ▶ Multi-functional. Designed for construction and repair.
- ▶ Robust rake head design; four different sizes.
- ▶ Long teeth tackle grading. Straight edge handles leveling.
- ▶ 66" (168 cm) straight handle.

24" (61 cm) Head	71124
30" (76 cm) Head	71130
36" (91 cm) Head	71136
42" (107 cm) Head	71142



TWIST AND GUSSET BRACING

Serious strength ... for rough ground and hard knocks. Reinforced to eliminate head-to-handle wobble.

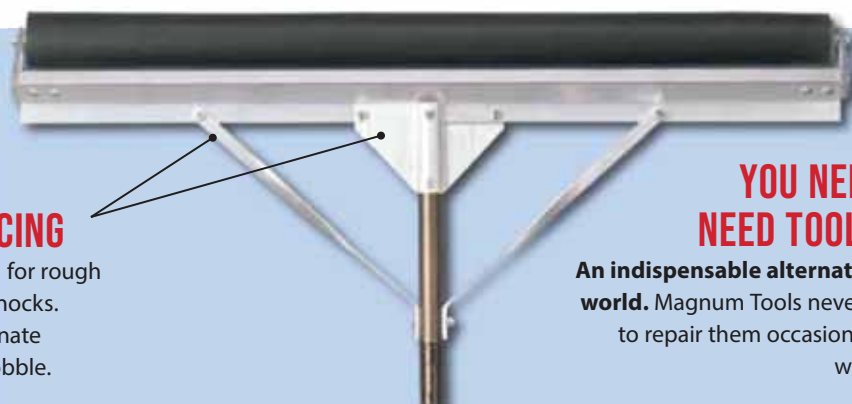

THE TOOLS YOU NEED WHEN YOU NEED TOOLS THAT LAST

An indispensable alternative to a disposable world. Magnum Tools never die. You may need to repair them occasionally, but you'll never want to replace them.



MAGNUM LANDSCAPE RAKE (SIFTING TOOTH)

- ▶ Sifting teeth separate stone and debris; flip over for straight edge leveling.
- ▶ 66" (168 cm) straight handle.

24" (61 cm) Head	71224
30" (76 cm) Head	71230
36" (91 cm) Head	71236
42" (107 cm) Head	71242



MAGNUM STRAIGHT-EDGE SQUEEGEE

- ▶ Keep shop floors dry. Remove cart path puddles with ease.
- ▶ Twist and gusset bracing for long life.
- ▶ 66" (168 cm) straight handle.

24" (61 cm) Head	72224
36" (91 cm) Head	72236

MAGNUM SPIKE ROLLER

- ▶ Prepares fine turf for light overseeding. Breaks up moss and algae. Lightly aerates bentgrass greens and tee boxes.
- ▶ Polypropylene roller with fine 7/16" (1.1 cm) spikes.
- ▶ Stainless steel axles. Heavy-duty bolts and lock washers. Industrial-grade end caps.

57 1/2" (146 cm) ergonomically angled handle.

8" (20 cm) Head	71708
16" (41 cm) Head	71716



MAGNUM DOUBLE DUTY RAKE

- ▶ Long teeth for raking. Short teeth for scarifying.
- ▶ 36" (91 cm) wide workhorse with heavy-duty head.
- ▶ 66" (168 cm) straight handle.

Magnum Double Duty Rake	71836
-------------------------	-------

MAGNUM ROLLER SQUEEGEE

- ▶ Designed for turf or hard surfaces.
- ▶ Double brace system for maximum downward pressure.
- ▶ Efficient, non-absorbent foam rubber head.
- ▶ Stainless steel axle, heavy-duty bolts and lock washers and industrial-grade end caps.

57 1/2" (146 cm) ergonomically angled handle.

24" (61 cm) Head	71324
36" (91 cm) Head	71336
48" (122 cm) Head	71348



REPLACEMENT SQUEEGEE ROLLER

24" (61 cm) Head	71325
36" (91 cm) Head	71337
48" (122 cm) Head	71349

MAGNUM LUTE

- ▶ Top-dresses smaller areas. Clears aeration plugs from greens and tees.
- ▶ Reversible blade lets you push or pull material.
- ▶ 66" (168 cm) straight handle.

24" (61 cm) Head	71424
36" (91 cm) Head	71436





MAGNUM GENERAL PURPOSE BROOM

- ▶ For everyday cleanup.
- ▶ Reinforced head/handle design.
- ▶ Ergonomically-angled 57 1/2" (146 cm) handle.
- ▶ 24" (61 cm) head.

Magnum General Purpose Broom	72100
------------------------------	-------

MAGNUM MAXIMUM DUTY BROOM

- ▶ 28" (71 cm) all-aluminum head with twist and gusset bracing.
- ▶ Scrape edge removes caked-on material.
- ▶ To soften brush action, simply remove one row of bristles.
- ▶ Ergonomically angled 57 1/2" (146 cm) handle.

Magnum Maximum Duty Broom	72125
---------------------------	-------



SPRING BRACE RAKE

- ▶ Heavy-duty spring keeps all 24 teeth close to the ground.
- ▶ Heavy-duty tines are braced for consistent raking action.
- ▶ 54" (137 cm) powder-coated aluminum handle with grip.
- ▶ 24" (61 cm) head.

Spring Brace Rake	72400
-------------------	-------



DEBRIS RAKE

- ▶ Great for removing pine needles and as a replacement for traditional bunker rakes.
- ▶ Gusseted head adds extra strength for demanding locations such as waste areas.
- ▶ 9" (23 cm) rake is perfect for maintaining between shrubs, flower beds or any other tight area.
- ▶ Mounts to 60" (152 cm) padded fiberglass handle for maximum strength, reach and comfort.

21" (53 cm) Debris Rake	11300
-------------------------	-------

Set of Two



STRUCTRON SHOVEL

NEW!

- ▶ 14 gauge #2 head, forward turned step.
- ▶ PowerCore solid fiberglass reinforcing rod.
- ▶ Fiberglass handle with poly D-grip, handling, more comfort, less strain.

	29" (74 cm) yellow fiberglass poly D-grip handle	48" (122 cm) yellow fiberglass handle
Drain Spade	71501	-
Round Point Shovel	71626	71601
Square Point Shovel	71676	71651

MAGNUM TOOL RACK

- ▶ Get a REAL tool rack that lasts!
- ▶ Heavy-duty, powder-coated in white.
- ▶ Rugged welded tubular channel holds heaviest tools.

12" (31 cm) Magnum Tool Rack	74000
24" (61 cm) Magnum Tool Rack	74100



24" (61 cm) Model

12" (31 cm) Model

MAGNUM MONSTER BROOM

- ▶ Perfect for removing dew or worm casts from greens and tees.
- ▶ Makes short work of shop floors and tennis courts.
- ▶ Two rows of replaceable bristles — mounted to a giant 84" (213 cm) head with 40" (102 cm) handle.
- ▶ Soften broom action by simply removing a row of bristles.

Magnum Monster Broom	72150
----------------------	-------

BUNKER DEBRIS SIEVE

- ▶ The easy way to sift sand to remove bunker debris and stones.
- ▶ 19" (48 cm) head;
- ▶ 72" (183 cm) handle.



1/2" (1.3 cm) Openings	29325
1/4" (0.6 cm) Openings	29350

LEVELAWN

- ▶ Distributes application materials.
- ▶ Removes stones from soil, breaks up small clods of sand or loam.
- ▶ Smoothes soil for easy planting.



72" (183 cm) handle	
30" (76 cm) Levelawn	29300
36" (91 cm) Levelawn	29375

HEAVY-DUTY IRRIGATION HEAD TRIMMER

- ▶ Trim thick grasses – even remove roots – around irrigation heads or yardage markers.
- ▶ One handle works with a wide range of head sizes.
- ▶ Plated-steel construction.
- ▶ Trimmer head dimensions are outside diameters.

Order handle and head separately.

Handle Only	29900
5" (12.7 cm) Head Only	29905
6" (15.2 cm) Head Only	29906
7" (17.8 cm) Head Only	29907
8" (20.3 cm) Head Only	29908
9" (22.9 cm) Head Only	29909
10" (25.4 cm) Head Only	29910
11" (27.9 cm) Head Only	29911

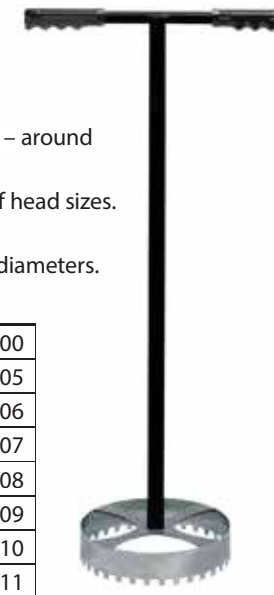

IRRIGATION HEAD TRIMMER

- ▶ One-time adjustable cutting blade (additional replacement blades available).
- ▶ Heavy-built with polished, stainless steel construction.
- ▶ Blades are plated-steel construction.
- ▶ Handle is powder-coated.
- ▶ One-time adjustable from 4"-11" (10.2 cm-28 cm).

32" (81 cm) handle

Irrigation Head Trimmer	29600
Replacement Blade	29601



SOIL PROFILE SAMPLER

- ▶ Quickly pull a clean root zone sample.
- ▶ Check roots in fine turf areas.
- ▶ Steel construction.
- ▶ Zinc-plated, case-hardened blade.
- ▶ 8"H x 4"W x 3/4"D (20 cm x 10 cm x 2 cm) samples.

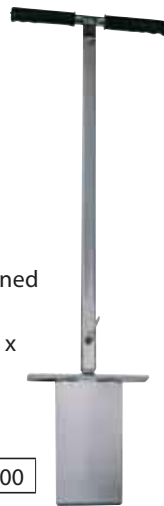

Soil Profile Sampler 29400

HEXAGON TURF REPAIR TOOL

- ▶ Innovative plug design for easy sod/soil removal and seamless replacement.
- ▶ Six-sided plugs pull wedges that are 7"W x 4"D (18 cm x 10 cm).

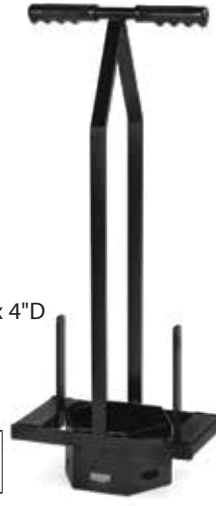

Hexagon Turf Repair Tool 29225

TURF DOCTOR

- ▶ Invisible sod replacement!
- ▶ Finish patch areas without leaving holes or gaps (i.e., irrigation repair).
- ▶ Razor-sharp blades (4) secure 9" (23 cm) square-cut, wedge-shaped sod blocks that fit and butt perfectly.



Turf Doctor 29200

HAND AERIFIER

- ▶ Choose solid or hollow tines; 2 1/4" (5.7 cm) penetration.
- ▶ Rugged steel construction. Core collector is built right into the base.
- ▶ 3" x 3/8" (7.6 cm x 0.95 cm) replaceable tines on 2" (5 cm) centers.



Order body assembly and tine base assembly separately.

Body Assembly Only	29808
Hollow Tine Base Assembly	29803
Solid Tine Base Assembly	29805

8" (20.3 CM) PRO II HOLE CUTTER/REPAIR TOOL

- ▶ Made for installing 8" (20.3 cm) special event cups, and perfect for quick and easy turf repairs.
- ▶ Expeller assembly makes ejecting 8" (20.3 cm) plugs a breeze – minimizing frustration and wasted time.
- ▶ Replaceable 8" (20.3 cm) inside sharpened shell also available.



8" (20.3 cm) diameter

Pro II Hole Cutter Straight Inside 28785

GREENSKEEPER BALL MARK REPAIR TOOL

- ▶ Great time-saving, labor-saving tool for quick, near-flawless repairs on greens.
- ▶ 36" (91 cm) handle makes repairs fast and easy.
- ▶ Meticulously lifts dirt and grass into place in one motion.



Greenskeeper 27200



2" (5 CM) TURF PLUGGER

- ▶ Ideal for replacing small areas of damaged turf. Fill the tube handle with new plugs from any nursery area, then use them to replace damaged plugs when you cut them.
- ▶ Zinc-plated construction.
- ▶ Adjustable blade handles plugs up to 4" (10 cm) deep.

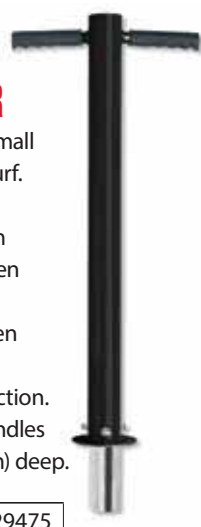

Turf Plugger 29475

DU-WHIPPER

- ▶ Sweep away morning dew, worm casts and bunker sand instantly.
- ▶ Easy to handle. Even easier to transport.
- ▶ Telescoping fiberglass pole stretches 6' to 16' (2 m to 5 m).
- ▶ Durable threaded cap.



Order replacement tips in our parts list, page 95.

Du-Whipper 34200

COCO FIBER DRAG MAT

- ▶ Two sizes for different needs and budgets.
- ▶ Spreads top dressing with a soft, smooth touch. Perfect for all playing surfaces.
- ▶ Tough, resilient fibers 1 1/4" (3 cm) bond to vinyl-reinforced backing.
- ▶ Smaller lighter-weight mat makes it easy for one operator to use.
- ▶ 10' (3.0 m) chain hooks up to any vehicle.

	Weights 65 lb (29 kg)	Weights 35 lb (16 kg)
4' x 6' (1.2 m x 1.8 m) Drag Mat	53000	-
3' x 5' (0.9 m x 1.5 m) Drag Mat	-	53050

NEW & IMPROVED

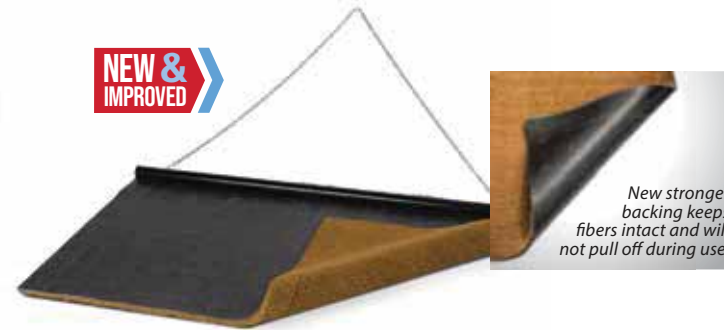

New stronger backing keeps fibers intact and will not pull off during use.

CORE PROFILE SAMPLER

- ▶ Triple window tine for fast and simple reads on soil strata.
- ▶ Removable "T" handle pushes cores through top of tube; fits inside for easy storage.
- ▶ Stainless-steel tine and handle construction.
- ▶ 12" (30 cm) tine.
- ▶ 3/4" x 10" (2 cm x 25 cm) samples.
- ▶ Includes convenient storage case.



Core Profile Sampler 29450

BIODEGRADABLE LANDSCAPE SPIKES

- ▶ Organic spikes in 4" (10 cm) and 6" (15.24 cm) hold new sod in place.
- ▶ Dissolves in approximately eight months (depending on soil conditions).
- ▶ 500 per carton.



NEW!

	4" (10 cm)	6" (15.24 cm)
Biodegradable Landscape Spikes	32300	32150

WIRE LANDSCAPE STAPLES

- ▶ Use to anchor sod and landscape covers, or even to hold hoses in place.
- ▶ Heavy-gauge steel; 6"H x 2"W (15 cm x 5 cm).
- ▶ 504 per carton.



Wire Landscape Staples 32100

DRAG BRUSH

- ▶ Long-time classic and favorite among superintendents.
- ▶ Gently and evenly works top dressing material into the green and helps control thatch when used before mowing.
- ▶ Extensions available for bigger jobs; hinged and weighted to help manage contours and uneven areas.
- ▶ Replacement brushes are priced separately. Two are needed for drag brush. Four are needed for extension.

26"H x 54 1/2"W (66 cm x 138 cm)

Drag Brush Only	52000
Replacement Brush	52013

26"H x 27"W (66 cm x 69 cm)

Set of Two Extensions	52050
Replacement Brush for Extension	52063

Drag Brush shown with optional extensions attached.



WEED WAND

- ▶ For precision chemical applications around flowerbeds, fragile plantings and other tight areas.
- ▶ Lightweight, 36" (92 cm) wand is designed to minimize spills, and for easy refills.
- ▶ 1" (2.5 cm) diameter applicator tips precisely control chemical flow and eliminate overspray.



Holds 8 oz (237 ml) of chemical solution.

Weed Wand	29700
Replacement Tips Five per pack	29701

BALL RETRIEVER

- ▶ Powder-coated 5 1/4" (13 cm) diameter aluminum holder attaches to any length pole.

Ball Retriever 12100





RUST-OLEUM SPRAYSMART MARKING PAINT SYSTEM

Golf course markings have never been easier! The SpraySmart system is a patent-pending, propellant free spray system for spraying marking paint. The reusable device operates on compression technology to spray paint using SpraySmart disposable paint pouches. You get the same great coverage, color and durability you would expect from a Rust-Oleum product but with less waste.

- ▶ Propellant free formula sprays on any substrate and in any weather condition; even works on dew covered grass.
- ▶ Designed to fully empty each paint pouch – no waste.
- ▶ Bright and durable colors are safe for grass.
- ▶ Space saving paint pouches can be easily stored or shipped (including overnight air shipping).
- ▶ Device fits in existing marking paint wands.
- ▶ Non-clogging spray tip provides one pass coverage.

SpraySmart Device	57000
Marking Wand	55000



SPRAYSMART PAINT POUCHES
10.5 oz pouches (311 ml)
Twelve pouches per case.

White	57001
High Visibility Yellow	57002
Safety Red	57003
Alert Orange	57004
Safety Green	57005
Caution Blue	57006
Fluorescent Pink	57007
Fluorescent Orange	57008
Fluorescent Green	57009
Fluorescent Red/Orange	57010
Black	57011
Caution Yellow	57012
Safety Purple	57013



E-ZEE WHITE HOLE WHITENER SYSTEM



- ▶ Clean, crisp white holes! Made quick and easy!
- ▶ Simply insert paint can into tool and rotate.
- ▶ New and improved formula for a brighter white tour grade finish.
- ▶ Built-in shield protects cup and green from overspray.
- ▶ Longer lasting and better coverage.

- ▶ One-piece patented design; no assembly required.
- ▶ No purging required between uses.
- ▶ Starter kit includes tool, plus one case of paint. (Six 15-oz [0.42 kg] cans per case.)

E-ZEE White Tool	55600
E-ZEE White Paint (Case)	55700
E-ZEE White Starter Kit	55500

RUST-OLEUM MARKING PAINT

More feet per can. Fewer cans of paint to buy. Every foot of Rust-Oleum Marking Paint you lay down is more money saved. Available in 13 vivid colors for temporary markings on grass, gravel, concrete or asphalt. Twelve 17 oz (0.48 kg) cans per case.

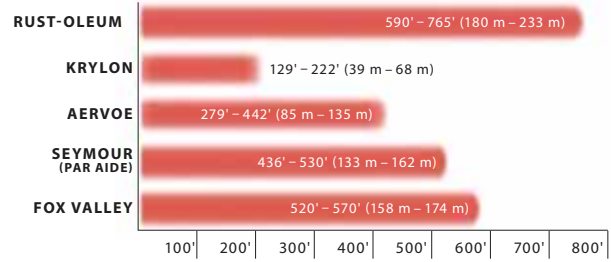

White	55001
High Visibility Yellow	55002
Safety Red	55003
Alert Orange	55004
Safety Green	55005
Caution Blue	55006
Fluorescent Pink	55007
Fluorescent Orange	55008
Fluorescent Green	55009
Fluorescent Red/Orange	55010
Black	55011
Caution Yellow	55012
Safety Purple	55013

RUST-OLEUM PRECISION LINE INVERTED MARKING CHALK

- ▶ Use white chalk for pin events and green chalk to mask unsightly areas.
- ▶ Applies quickly, washes away with water.
- ▶ Twelve 17 oz (0.48 kg) cans per case.

White	55301
Green	55302



STRIPING MACHINES

- ▶ Built to last with solid steel construction.
- ▶ Tilt-away handle for easy storage.
- ▶ Athletic Field model comes with larger wheels (vs. Hard Surface units).
- ▶ Both units carry twelve cans of paint.
- ▶ Adjust stripe width between 2" (5 cm) and 4" (10 cm).

Athletic Field Striping Machine	55100
Hard Surface Striping Machine	55200



MARKING WAND

- ▶ Accurate. Easy to load and shoot. Compatible with any brand of marking paint.
- ▶ Inverted wand – 35" (89 cm) long – is used to mark hazards and ground under repair.
- ▶ Lightweight construction also makes it ideal for greens and pin events.

Marking Wand	55000
	\$29.75

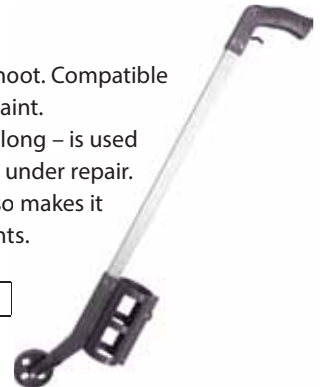

RUST-OLEUM STRIPING PAINT

- ▶ Applies quickly.
- ▶ Athletic Field striping paint washes away with water.
- ▶ Hard Surface striping paint for permanent applications.
- ▶ Striping paint will fit in Striping Machine.



	ATHLETIC FIELD STRIPING PAINT 17 oz cans (0.5 kg) Twelve cans per case	HARD SURFACE STRIPING PAINT 18 oz cans (0.5 kg) Six cans per case
White	55101	55204
Yellow	55103	55205
Orange	55102	-
Black	-	55201
Blue	-	55202
Red	-	55203

PRACTICE GREEN TARGET

- ▶ Mark your practice greens without cutting a hole.
- ▶ All-metal targets; perfect for lessons and events, easy to move around.
- ▶ Compatible with Standard Golf Small Tube Practice Green Flags and Cast Aluminum Practice Green Markers to match your course décor.
- ▶ Flags and markers not included.

Rod: 1/4" (0.6 cm) diameter
23 1/2" (60 cm) long. Spike: 5" (13 cm) long

Rod and Knob

 Red	20100
 White	20101
 Black	20103



NUMBERED PRACTICE GREEN FLAG SETS

- ▶ Premium Nylon Tube-Lock Flags.
- ▶ Order them in single units (one flag, rod, knob and base) or as a set (nine units).
- ▶ Made with DuPont SolarMax nylon.
- ▶ Small tube flags fit practice green rods. Large tube flags fit Junior Tournament rods.

PRACTICE GREEN RODS WITH SMALL TUBE FLAGS

Rod: 3/8" (1.0 cm) diameter
28" (71 cm) long



SMALL TUBE FLAG ONLY with rod, knob and base **SINGLE UNIT** with rod, knob and base **SET 1-9** with rod, knob and base

 Red Flag/White Rod	20612*	20692*	20691
 White Flag/Red Rod	20712*	20792*	20791
 Yellow Flag/Black Rod	20812*	20892*	20891

JUNIOR TOURNAMENT RODS WITH LARGE TUBE FLAGS

Rod: 1/2" (1.3 cm) diameter tip and ferrule
lead to 3/4" (1.9 cm) diameter center
32" (81 cm) long

LARGE TUBE FLAG ONLY with rod, knob and base **SINGLE UNIT** with rod, knob and base **SET 1-9** with rod, knob and base

 Red Flag/White Rod	20616*	20672*	20671
 White Flag/Red Rod	20716*	20772*	20771
 Yellow Flag/Black Rod	20816*	20872*	20871



*Specify hole numbers by adding a hyphen (-) and hole number at the end of the product number. Ex: 20616-3.

NUMBERED PRACTICE GREEN PENNANT SETS

- ▶ Classic, one-piece plastic head and fiberglass rod combinations.
- ▶ Order them in single units (one plastic head, rod and base) or as a set (nine units).

Rod: 3/8" (1 cm) diameter
28" (71 cm) long

HEAD & ROD ONLY **SINGLE UNIT** with rod and base **SET 1-9** with rod and base **SET 10-18** with rod and base

 White Head/Red Rod	20393*	20392*	20391	20390
 White Head/Green Rod	20493*	20492*	20491	20490
 Black Head/Yellow Rod	20593*	20592*	20591	20590

*Specify hole numbers by adding (-) and hole number at end of product number. Ex. 20392-2.
To order without numbers, add (-P) to the end of product number. Ex. 20392-P.

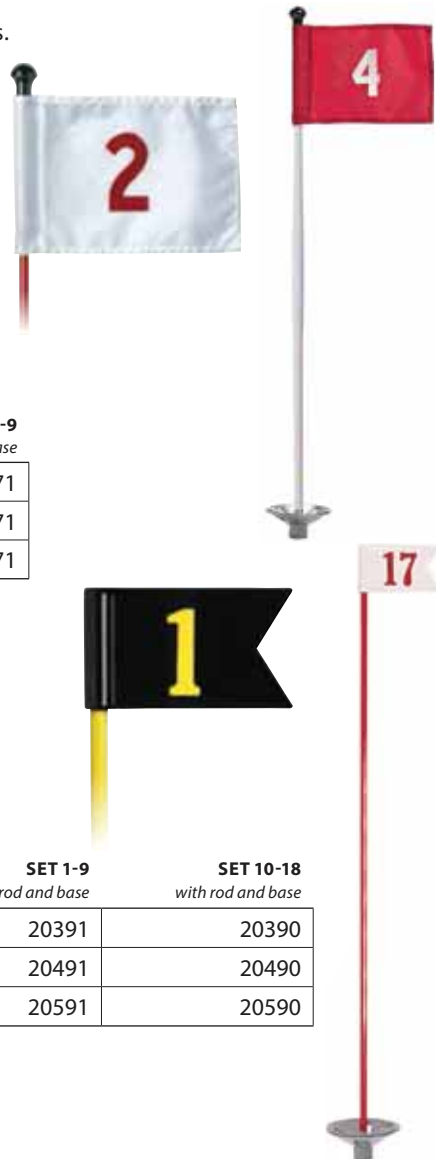

DOMED RESIN TEE MARKER DECALS

- ▶ Brand your tee markers to match special events, tournaments, club logo or even your signature hole or clubhouse.
- ▶ Available to fit Standard Golf's dimple tee marker, wedge tee marker, and cast aluminum marker.
- ▶ All images are covered with a crystal clear resin dome using "automotive grade" resin to protect it from the elements and give a 3-D professional look.
- ▶ Self-adhesive resin material.
- ▶ Sold in quantities of 18, 36, 54, 72, 108, 144, or 216.
- ▶ Printed using four-color process print technology.

PERSONALIZED DECALS

Decal: 3" (7.6 cm) diameter

Order of 18	20311
Order of 36	20312
Order of 54	20313
Order of 72	20314
Order of 108	20315
Order of 144	20316
Order of 216	20317

Shown on red Dimple-T Marker



ALUMINUM PRACTICE GREEN CUP

- ▶ Bonderite coated aluminum; the most chip-resistant coating around.
- ▶ Beveled bottom edge design makes cup easier to insert and remove.

4" (10 cm) high 4 1/4" (10.8 cm) diameter

Aluminum Practice Green Cup	18150
-----------------------------	-------



Shown with beveled edge at bottom.

PLASTIC PRACTICE GREEN CUP

- ▶ Features molded plastic construction and reinforced webs.

4" (10 cm) high 4 1/4" (10.8 cm) diameter

Plastic Practice Green Cup	18100
----------------------------	-------



SOLID METAL BASE

Metal Base	20322
------------	-------



KNOBS FOR PRACTICE GREEN FLAGSTICK

Fits 3/8" (1 cm) diameter rods only

Flagstick Knob	20822
----------------	-------

Fits 1/2" (1.3 cm) diameter rods only



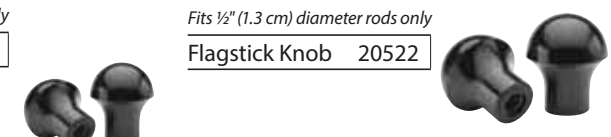



Flagstick Knob	20522
----------------	-------



CAST ALUMINUM PRACTICE GREEN MARKER

- ▶ The resiliency and functionality of cast aluminum.
- ▶ Plain or personalized with sets of numbered decals or your club logo.
- ▶ Fits 3/8" (1 cm) practice green rods and targets.
- ▶ Rods and targets are not included.

HEAD ONLY

 White	20532
 Yellow	20533
 Red	20534
 Green	20535
 Blue	20536
 Black	20537





NUMBERED AND PERSONALIZED DECALS

- ▶ Add numbered or personalized decals with your club's logo to your cast aluminum heads and tee markers.
- ▶ Numbered decals ship with two sets of numbers (one for each side).

NUMBERED DECALS

3" (7.6 cm) diameter 1-9

 White	20541
 Red	20561
 Black	20581



PERSONALIZED DECALS

Order of 36	20511
Order of 54	20512
Order of 72	20513
Order of 108	20514
Order of 144	20515
Order of 216	20516



Prices are valid for any number of color combinations.
Ask your distributor or email orders@StandardGolf.com to customize any of these products with your logo.

Art Charge	21300
------------	-------

PRACTICE GREEN ROD

- ▶ Solid, resilient fiberglass construction.
- ▶ 3/8" (1 cm) diameter; 28" (71 cm) long.
- ▶ Knob and base sold separately.

Fits 3/8" (1 cm) diameter rods only

Flagstick Knob 20822



Metal Base 20322



SOLID ROD ONLY

Red	20182
Black	20282
White	20382
Yellow	20482
Green	20682

STRIPED ROD ONLY

Black/White	20010
White/Red	20020
Yellow/Black	20030
Green/White	20040

Custom Colored Striping

Email orders@StandardGolf.com or contact your distributor for pricing.



Fits large tube practice green flags.

Fits small tube practice green flags.

JUNIOR TOURNAMENT ROD

- ▶ New lighter, more flexible material allows for longer lifetime and durability.
- ▶ 1/2" (1.3 cm) diameter tip and ferrule leads to a 3/4" (1.9 cm) diameter center; 32" (81 cm) long.
- ▶ Fits 1/2" (1.3 cm) practice green flags only.
- ▶ Knob and base sold separately.
- ▶ Base tip is now molded into the rod.

SOLID ROD ONLY

White	20200
Yellow	20225
Black	20227
Red	20228

STRIPED ROD ONLY

Black/White	20201
Red/White	20202
Green/White	20203
Black/Yellow	20226

Fits 1/2" (1.3 cm) diameter rods only

Flagstick Knob 20522



Metal Base 20322



Custom Colored Striping Email orders@StandardGolf.com or contact your distributor for pricing.



PLAIN PRACTICE GREEN FLAG

- ▶ Now available in 1/2" (1.3 cm) size to fit Junior Tournament practice green rods and Par Aide practice green rods.
- ▶ Customize with your logo (see below).
- ▶ Made with DuPont SolarMax nylon.



5 1/2" x 8" (13.9 cm x 20.3 cm)

	SMALL TUBE Fits 3/8" (1 cm) Rod	LARGE TUBE Fits 1/2" (1.3 cm) Rod
Green	20594	20596
Red	20694	20696
White	20794	20796
Yellow	20894	20896
Blue	20994	20996
Orange	20494	20496
Black	20394	20396

Single Flag

CUSTOMIZED PRACTICE GREEN FLAGS

- ▶ Revolutionary, state-of-the-art dye sublimation process.
- ▶ Full-color printing capabilities create photo-quality logo reproduction.
- ▶ Maximum UV-resistant material helps maintain long-lasting color.
- ▶ More versatile and economical when compared to traditional screen printed or embroidery processes.
- ▶ Available in 3/8" (1 cm) and 1/2" (1.3 cm) sizes to fit Standard Golf and Par Aide® practice green rods.
- ▶ Minimum order of nine required for customized flags.



5 1/2" x 8" (13.9 cm x 20.3 cm)

	SMALL TUBE SINGLE Fits 3/8" (1 cm) Rod	SMALL TUBE SET OF NINE Fits 3/8" (1 cm) Rod	LARGE TUBE SINGLE Fits 1/2" (1.3 cm) Rod	LARGE TUBE SET OF NINE Fits 1/2" (1.3 cm) Rod
Customized 200 Denier Practice Green	25902	25900	25952	25950
Full Coverage Customized 200 Denier Polyester	25902F	25900F	25952F	25950F

Minimum order of nine. Each flag design can be individually customized. Art charges may apply.

PRACTICE GREEN FLAG SCREEN PRINTING CHARGES

- ▶ From one color to seven colors. Available on plain flags only.
- ▶ Prices shown do not include base flag cost (see above).



5 1/2" x 8" (13.9 cm x 20.3 cm)

	Set of Nine
One-Time Art Charge	21300
One-Color	20901
Two-Color	20902
Three-Color	20903
Four-Color	20904
Five-Color	20905
Six-Color	20906

Minimum order of nine.

CHECKERED PRACTICE GREEN FLAG

- ▶ For a classier, more distinctive look.
- ▶ Now available in 1/2" (1.3 cm) size to fit Junior Tournament practice green rods and Par Aide practice green rods.
- ▶ Made with DuPont SolarMax nylon.
- ▶ Available in both sewn and anco-printed styles.



5 1/2" x 8" (13.9 cm x 20.3 cm)

	ANCO-PRINT SMALL TUBE Fits 3/8" (1 cm) Rod	ANCO-PRINT LARGE TUBE Fits 1/2" (1.3 cm) Rod	SEWN SMALL TUBE Fits 3/8" (1 cm) Rod	SEWN LARGE TUBE Fits 1/2" (1.3 cm) Rod
Black/White	20912	20917	21912	21917
Red/White	20922	20927	21922	21927
Black/Yellow	20932	20937	21932	21937
Green/White	20942	20947	21942	21947

Single Flag

EMBROIDERED PLAIN PRACTICE GREEN FLAG

- ▶ The elegance of embroidery with UV-resistant, color-fast threads for lasting brightness.
- ▶ Includes set of nine plain practice green flags.



5 1/2" x 8" (13.9 cm x 20.3 cm)

	Set of Nine
Logo Tape Set-Up Charge	20990
Up to 8,000 Stitches	20950
Over 8,000 Stitches	Email orders@StandardGolf.com for quote

AMERICAN PRACTICE GREEN FLAG

- ▶ A nice touch on commemorative holidays.
- ▶ Anco-dye flag construction.



5 1/2" x 8" (13.9 cm x 20.3 cm)

	Fits 3/8" (1 cm) rods only.	Fits 1/2" (1.3 cm) rods only.
Single	20987	20787

MAGNUM HARVESTER BALL PICKER

World's best ball picker ... period!

Superior Dual-Integrated Gang Technology means each gang PIVOTS INDEPENDENTLY IN ANY DIRECTION for unequalled maneuverability on rolling terrain, in all types of grasses and conditions, when navigating slopes, even when backing away from trees and other obstacles.

- ▶ IT'S THE ONLY GANG PICKER IN THE WORLD THAT BACKS UP WITHOUT GETTING TANGLED OR DAMAGED.
- ▶ No need to exit the vehicle to untangle gangs.
- ▶ LOW-PROFILE – reaches under trees, sweeps close to yardage markers.
- ▶ Powder-coated finish ensures a superior, longer-lasting appearance and better rust resistance.
- ▶ Assembles in less than 15 minutes.
- ▶ U.S. and foreign patents pending.



NEW! IN-LINE MAGNUM HARVESTER BALL PICKER

Looking for a range ball picker that will not break the bank, but still can do the heavy lifting? Standard Golf's new In-line Magnum Harvester Ball Picker is the latest in the line of well-made range ball pickers from Standard Golf. Attach directly to a utility cart.

- ▶ Uses our patented split gang technology
- ▶ 5' wide with a 900-ball capacity
- ▶ Picks golf balls going forward or reverse

Actual Weight: 128 lb (58 kg)
Shipping Weight: 178 lb (81 kg)

In-Line Magnum Harvester Ball Picker	85500
--------------------------------------	-------



3-GANG UNIT

Covers 9 ft (2.7 m)

Actual Weight: 277 lb (126 kg)
Shipping Weight: 401 lb (182 kg)

3-Gang Unit	85000
-------------	-------



5-GANG UNIT

Covers 15 ft (4.6 m)

Actual Weight: 427 lb (194 kg)
Shipping Weight: 631 lb (287 kg)

5-Gang Unit	85100
-------------	-------



EXTENSION KIT

Converts a 3-Gang Unit to a 5-Gang Unit.

Actual Weight: 150 lb (68 kg)
Shipping Weight: 230 lb (105 kg)

Extension Kit	80300
---------------	-------



REPLACEMENT BASKET

300-Ball Capacity

Replacement Basket	83119
--------------------	-------

MAGNUM SENIOR HARVESTER BALL PICKER



Double the power of the Jr. Harvester. Side-by-side baskets give the Magnum Senior Harvester Ball Picker a 600-ball capacity. Easily push around a practice green, chipping area or even a small driving range.

- ▶ Uses our patented split gang technology.

Actual Weight: 60 lb (27 kg)
Shipping Weight: 108 lb (49 kg)

Magnum Senior Harvester Ball Picker	85400
-------------------------------------	-------



MAGNUM JR. HARVESTER BALL PICKER

For putting and chipping areas and hard-to-reach places. Perfect complement to the popular Harvester Ball Picker.

- ▶ Easy to handle. Ultra-strong 1 1/4" (3 cm) square tubular, chrome steel frame.
- ▶ 300-ball capacity basket.

Actual Weight: 40 lb (18 kg);
Shipping Weight: 45 lb (20 kg)

Magnum Jr. Harvester Ball Picker	85200
----------------------------------	-------



MAGNUM SCRUB-PRO GOLF BALL WASHER

- ▶ Cleans up to 12,000 balls an hour.
- ▶ Exclusive "dimple brush" design cleans even hard-caked dimples.
- ▶ Ships within 48 hours—and virtually ready-to-run right from the crate.

42"H x 35" W x 30"D (107 cm x 89 cm x 76 cm)
Basket Capacity: 375 golf balls Tank Capacity: 8 gallons (30.3 liters)

Magnum Scrub-Pro (115 Volt)	86000
Scrub-Pro Vibrator Motor (115 Volt)	86950
Magnum Scrub-Pro (230 Volt)	87000
Scrub-Pro Vibrator Motor (230 Volt)	87950



Polyethylene body and a tubular steel, powder-coated, chrome frame for maximum durability and rust-resistance.

MAGNUM BALL DISPENSER

- ▶ Holds up to 12,000 range balls and 2,800 disposable bags.
- ▶ Loads baskets or bags (70 balls max).
- ▶ 115 or 230 volt options available.



For more information go to: StandardGolf.com/balldispenser

ACE MULTI-PURPOSE CONTAINERS

- ▶ 8-gallon (30 L) Club Washer, Divot Mix or Trash Container.
- ▶ Attractive side panels dress up the range or tee area.
- ▶ UV-resistant material.
- ▶ Divot Mix and Trash Container include liners and lids.
- ▶ Club Washer includes two brushes and lid.
- ▶ All-purpose container does not include brushes, lid or liner.



	ACE ALL-PURPOSE CONTAINER 16" w x 16" h x 19" d (41 cm x 41 cm x 48 cm)	ACE DIVOT MIX CONTAINER 16" w x 16" h x 19" d (41 cm x 41 cm x 48 cm)	ACE TRASH CONTAINER 16" w x 16" h x 19" d (41 cm x 41 cm x 48 cm)	ACE CLUB WASHER 16" w x 16" h x 19" d (41 cm x 41 cm x 48 cm)
Green	01661	18910	12810	01660
Brown	01671	18920	12820	01670
Black	01681	18980	12830	01680

Single Replacement Brush 01602

Club Washer requires two brushes. Priced individually.

RANGE MATE CLUB WASHER

- ▶ Gentle, no-splash brushes will handle woods and irons.
- ▶ Efficient, effective design with replaceable brushes.
- ▶ Large-capacity, fade-resistant 9-gallon (34 L) polyethylene containers, reinforced with steel frame.
- ▶ New square opening allows easier access to clean clubs.

Hunter Green 01650

Single Replacement Brush 01602

Club Washer requires two brushes. Priced individually.



Use with Sparkleen Liquid Detergent. (See page 9.)

RECYCLED CLUB WASHER

- ▶ Premier Green Line Club Washer.
- ▶ Rugged construction includes 5-gallon (19 L) bucket and hand brush.

32"H x 17"W (81 cm x 43 cm)

Green	200010GN
Brown	200010BR
Black	200010BK



RANGE BALL PUSHER

- ▶ Make short work of your practice area cleanup.
- ▶ Proven design features durable PVC frame and exclusive rollers which glide easily across all turf surfaces.
- ▶ 44 1/2" (113 cm) wide head makes short work of collecting range balls.

44 1/2" (113 cm) head - 33 1/2" (85 cm) height

Range Ball Pusher 85300



RANGE MARKING POLE

- ▶ Give your range a unique look with these highly visible striped Range Marking Poles.
- ▶ Features high-strength 82" (208 cm) long, 3 1/2" (8.9 cm) diameter PVC pipe. UV-resistant paint for superior durability and easy target acquisition.
- ▶ 12" (31 cm) Ground Anchor holds it firmly in place. Ground Anchor sold separately.



82" (208 cm) long 3 1/2" (8.9 cm) diameter

Black/White	09750	-
Blue/White	09760	-
Green/White	09770	-
Red/White	09780	-
Special Color Stripe	-	09798



12" H x 3 3/8" W x 3 3/8" D
(31 cm x 9 cm x 9 cm)

Ground Anchor 09790

NYLON RANGE BANNER

- ▶ Crisp, bold-faced, brightly colored, easy-to-read distance banners.
- ▶ Sewn and fitted for PVC frame, which you can build yourself or order from us (see Range Banner Frame Kit below).

Horizontal:
26"H x 48"W (66 cm x 122 cm)
Vertical:
48"H x 26"W (122 cm x 66 cm)

	250		250	
	Horizontal	Vertical	Horizontal	Vertical
50 yards	31050H	31050V	35050H	35050V
75 yards	31075H	31075V	35075H	35075V
100 yards	31100H	31100V	35100H	35100V
125 yards	31125H	31125V	35125H	35125V
150 yards	31150H	31150V	35150H	35150V
175 yards	31175H	31175V	35175H	35175V
200 yards	31200H	31200V	35200H	35200V
225 yards	31225H	31225V	35225H	35225V
250 yards	31250H	31250V	35250H	35250V
275 yards	31275H	31275V	35275H	35275V
300 yards	31300H	31300V	35300H	35300V



RANGE BANNER FRAME KIT (HEAVY-DUTY)

For both horizontal or vertical banners.

- ▶ Frame, tees and elbows - 1 1/2" (3.8 cm) diameter.
- ▶ Ground Anchors - 10" (25 cm) long.
- ▶ Order one kit per banner.

Frame, tees and elbows - 1 1/2" (3.8 cm) diameter
Ground Anchors - 10" (25 cm) long

Range Banner Frame Kit 31000



RANGE FLAGS

- ▶ Five nylon flags for 50/100/150/200/250 yardages.
- ▶ Flags measure 18" x 25" (46 cm x 64 cm) and include Snap-Lock swivel snaps.

	PLAIN FLAG (no numbers)	NUMBERED FLAGS (set of five distances)
Red	22010	22116
White	22020	22115
Yellow	22030	-
Orange	22040	-
Medium Blue	22050	-
Green	22060	-
Black	22070	-

VERTICAL RANGE FLAG

- ▶ Make your range stand out with these oversized vertical flags.
- ▶ Integrated tube design fits all regulation flagsticks, making installation a snap.
- ▶ Top nut can be adjusted so flag moves with the wind or stays in a fixed position.
- ▶ Includes flag, mounting rod, and hex flange locknut with nylon insert.



VERTICAL RANGE FLAG
40"H x 15 1/2"W (102 cm x 39.4 cm)

Yellow/Black-50	-	60050
Yellow/Black-100	-	60100
Yellow/Black-150	-	60150
Yellow/Black-200	-	60200
Yellow/Black-250	-	60250
Red	60510	-
White	60520	-
Yellow	60530	-
Orange	60540	-
Medium Blue	60550	-
Green	60560	-
Black	60570	-

DELUXE RANGE BALL CRATE

Dress up your driving range with our new Deluxe Range Ball Crate. With a capacity of 250 range balls, this new crate will give your range a sophisticated look. Made from the same material as our Recycled Bag Stands to complete your range.



NEW!

20.5" W x 10" D x 9" H
(52 cm x 25.4 cm x 22.9 cm)

Green	100150GN
Black	100150BK
Brown	100150BR

RANGE DIVIDER

- Simple solution to designate hitting areas on your range.
- Deluxe model's built-in handle makes set up a breeze.
- Steel spikes included for turf ranges.

RANGE DIVIDER 48"L x 4"H x 2"D
(122 cm x 10 cm x 5 cm)

DELUXE RANGE DIVIDER 48"L x 6 1/2"H x 2"D
(122 cm x 17 cm x 5 cm)

Green	100170GN	100175GN
Brown	100170BR	100175BR
Black	100170BK	100175BK
White	100170WH	-



Deluxe

FLAGSTICK STAND

- Perfect for displaying flagsticks indoors.
- Powder-coated steel for increased durability.
- Stand can be mounted for temporary or permanent use.



2 1/4"H x 7 1/2" diameter (6 cm x 19.1 cm)

Flagstick Stand	26800
-----------------	-------

EASYMARK SYSTEM

- Put a flagstick anywhere, without cutting a cup hole.
- EasyMark for 1/2" (1.3 cm) non-ferruled rod (cannot accept flag).
- EasyMark II for ferruled flagsticks (can accept flags).
- Versatile tap-in anchor makes it easy to set up flags for special events or on the range.

EasyMark 6" (15 cm) long 3" (7.6 cm) diameter
Rod 5' (152 cm) high 1/2" (1.3 cm) diameter

EasyMark II*	26760
EasyMark	26755
EasyMark with Rod**	26750



*Can accept regular flagsticks with ferrule.
**Rod cannot accept flag.

RANGE ALIGNMENT ROPE

Set up the range in seconds.

- Handy spool ... with 100' (30.5 m) of rope.
- 10 equidistant markers help you evenly space range dividers and place bag stands.
- 5/16" (0.79 cm) twisted polypropylene rope.



Each spool carries 100' (30.5 m) of rope. Markers — spaced every 10' (3 m) — show you just where to place range dividers.



Range Alignment Rope	36700
----------------------	-------

CLOCK-ON-POST

- Perfect for ranges or practice greens.
- Comes with sturdy stand alone support post which can be secured with spikes.
- Clock-On-Post features a 12" (30.5 cm) clock.
- Deluxe models feature 18" (45.7 cm) diameter atomic clock with built-in temperature and hydrometer gauges.
- Includes four ground spikes.
- Limited warranty.



Deluxe Clock-On-Post

ADD YOUR LOGO
SEE PAGE 20

CLOCK-ON-POST 36"H x 4"W x 4"D
(91 cm x 10 cm x 10 cm)

DELUXE CLOCK-ON-POST 48"H x 4"W x 4"D
(122 cm x 10 cm x 10 cm)

Green	100115GN	100110GN
Brown	100115BR	100110BR
Black	100115BK	100110BK



Deluxe Model

EASEL CLOCK (SINGLE-SIDED)

- A striking addition to #1 and #10 tee boxes and clubhouse.
- Easel clock features 12" (30.5 cm) clock.
- Deluxe model features 18" (45.7 cm) diameter atomic clock with built-in temperature and hydrometer gauges.
- Limited warranty.

EASEL CLOCK 23"H x 16"W (58 cm x 41 cm)

DELUXE EASEL CLOCK 22"H x 28"W (56 cm x 71 cm)

Green	100100GN	100120GN
Brown	100100BR	100120BR
Black	100100BK	100120BK

SIX-YARDAGE EASEL (SINGLE-SIDED)

- Post up to six easy-to-read range flag distances with coordinated and customized flag colors.
- Larger model comes with 12" (30.5 cm) diameter clock.
- Includes six sets of numbers (0-8) for posting sign yardages.
- Limited warranty.
- Custom order. Allow 3-4 weeks.

SIX-YARDAGE EASEL 32"H x 22"W (81 cm x 56 cm)

SIX-YARDAGE CLOCK EASEL 40"H x 32"W (102 cm x 81 cm)

Green	100130GN	100140GN
Brown	100130BR	100140BR
Black	100130BK	100140BK



REPLACEMENT CLOCK

- Weather-resistant.
- Two models:
 - 12" diameter (30.5 cm) Easel Replacement Clock.
 - 18" diameter (45.7 cm) Deluxe Easel Atomic Clock features built-in temperature and hydrometer gauges.
- Limited warranty.

12" (30.5 cm) Clock - White	200900
18" (45.7 cm) Atomic Clock - Silver	200902



PREMIERE BAG STAND

Hitting the range with all your tools means you need more places to set your items. Our Premiere Bag Stand comes with cut out components for your tees, mobile phone, car keys, and beverage. Set your full bag inside the stand or take individual clubs and rest them in the notches for each club. The top and bottom of this bag stand will always be black, but the "stand" can be green, black or brown.

NEW!

28"H x 19"W (71 cm x 48 cm)

Green	100810GN
Black	100810BK
Brown	100810BR

Some assembly required

RECYCLED BAG STAND WITH CUP HOLDER

- ▶ This fold-up bag stand is a sharp addition to any area ... with extra room for a drink holder.
- ▶ Resilient, environmentally responsible construction.

28"H x 19"W (71 cm x 48 cm)

Green	100800GN
Brown	100800BR
Black	100800BK



RECYCLED BAG STAND

- ▶ A favorite on ranges everywhere.
- ▶ Rugged. Reinforced.
- ▶ Folds up for easy storage.

28"H x 19"W (71 cm x 48 cm)

Green	100700GN
Brown	100700BR
Black	100700BK



RECYCLED BAG RACK

- ▶ Clean, rugged, durable design.
- ▶ Five large bag slots.



31 1/2"H x 72"W (80 cm x 183 cm)

Green	100900GN
Brown	100900BR
Black	100900BK

DELUXE RECYCLED BAG RACK

- ▶ Upgrade with this ultra-durable recycled bag rack.
- ▶ Order multiple units and place side-by-side or back-to-back for added capacity.



31 1/2"H x 72"W (80 cm x 183 cm)

Green	100910GN
Brown	100910BR
Black	100910BK

BAG CADDIE

- ▶ Economical, streamlined and practical. Holds any size bag.
- ▶ Sharpened spikes for easy "step-in" anchoring.
- ▶ **Sold in multiples of two.**



44" (112 cm) high

Bag Caddy – Black (for 2 caddies)	36800
-----------------------------------	-------

BAG STAND

- ▶ Sturdy, wide-stance design for excellent stability.
- ▶ Durable powder-coated finish.
- ▶ Stackable to conserve space when stored.
- ▶ **Sold in multiples of two.**



26"H x 14"W x 25"D (66 cm x 36 cm x 64 cm)

Bag Stand – Green (for 2 stands)	36825
----------------------------------	-------

GREEN LINE PREMIUM ROPE STAKES

- ▶ Premium recycled plastic stakes with traditional tops.
- ▶ Zinc coated hardened steel spikes.
- ▶ Rope stakes include convenient speed slot for easy rope installation.
- ▶ **Sold in sets of twelve.**

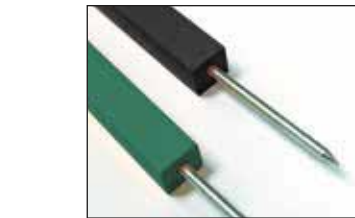

	12" (30 cm) SQUARE with spike	18" (46 cm) SQUARE with spike	24" (61 cm) SQUARE with spike
Green	42012	42018	42024
Black	42112	42118	42124

RECYCLED PLASTIC ROPE STAKES

These easy-to-place stakes don't crack, rot or absorb moisture.

- ▶ Accommodates 1/4" (0.64 cm) braided rope.
- ▶ **Sold in sets of twelve.**

5 1/2" (14 cm) spike
Round: 1 1/2" (3.8 cm) diameter
Square: 1 1/2" (3.8 cm)

	12" (30 cm) with spike		18" (46 cm) with spike		24" (61 cm) with spike	
	Round	Square	Round	Square	Round	Square
Green	38160	37850	38360	38050	38260	37950
Black	-	37875	-	38075	-	37975

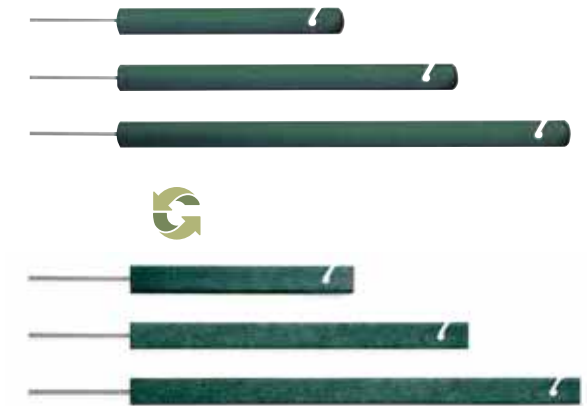

ECO-STEP ROPE AND CHAIN STAKES

Step them into the ground and hook either rope or chain to the multi-functional clasp top.

- ▶ 8" (20 cm) long, 3/8" (1 cm) diameter galvanized steel spike.
- ▶ Reinforced with long-lasting recycled polymers.
- ▶ **Sold in sets of twelve.**

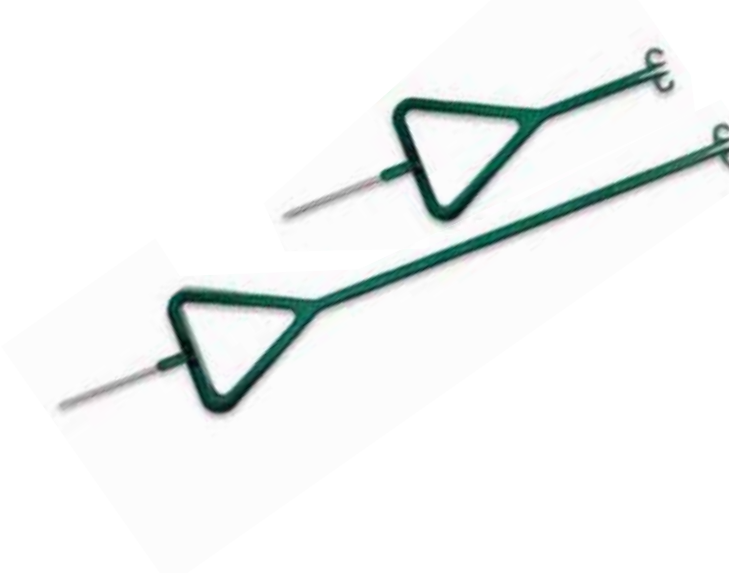

	15" (38 cm) with spike	32" (81 cm) with spike
Yellow	37600	-
Green	37650	37750

DELUXE STEEL COMBO ROPE & CHAIN STAKE

NEW!

- ▶ Available in three colors (chrome, green and yellow).
- ▶ Stakes allow the user to string across either rope or chain.
- ▶ New smaller 3/8" (.95 cm) diameter to help reduce weight and shipping costs.
- ▶ Choice of either a 25" (63.5 cm) or 36" (91 cm) above ground stake.
- ▶ A 10" (25.4 cm) spike is attached.

Sold in sets of 12	DELUXE STEEL COMBO ROPE & CHAIN STAKE 25" (63.5 cm)	DELUXE STEEL COMBO ROPE & CHAIN STAKE 36" (91.44 cm)
	Green	38330
Chrome	38310	38410
Yellow	38320	38420



BRAIDED ROPE

- ▶ 1/4" (0.64 cm) diameter polypropylene braided rope.
- ▶ 1000' (304 m) per spool.

Yellow	37100
Green/White	37150
Green	37200
Black	37250

Splicing Fid for 1/4" (0.64 cm) Rope	37299
--------------------------------------	-------



STEEL ROPE STAKES

- ▶ Popular, value-priced solution.
- ▶ Positions easily with foot pressure.
- ▶ 6" (15 cm) long, 5/16" (0.79 cm) diameter spike.
- ▶ Sold in sets of twelve.

	14" (36 cm)	32" (81 cm)
Yellow	37400	37500
Green	37450	37550

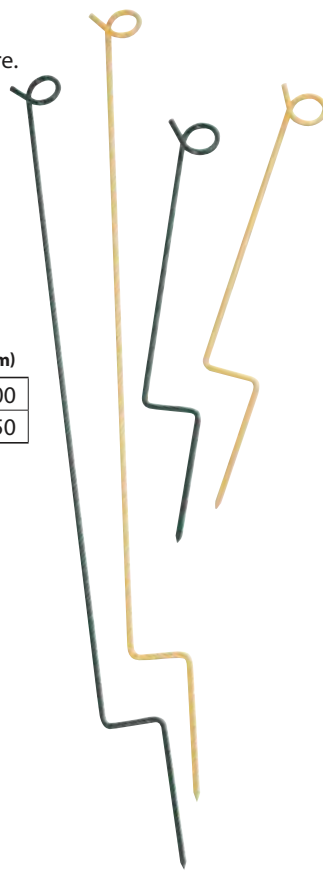

WRAPAROUND SAFETY GLASSES

- ▶ One-piece wraparound lens allows maximum safety and unobstructed vision.
- ▶ Flexible temples and non-slip rubber head grips.

Clear	75000
Tinted	75050

SOFT FOAM EARPLUGS

- ▶ Made of self-adjusting foam with a tapered shape for increased comfort.
- ▶ Each pair of earplugs comes in a poly bag, keeping them clean before use.

Sold in boxes of 200

Soft Foam Earplugs	75100
--------------------	-------

DISPOSABLE GENERAL-PURPOSE NITRILE GLOVES

- ▶ Superior tear strength and dexterity.
- ▶ Chemical-resistant.
- ▶ 4 mil thick.

Sold in boxes of 100

Large	75300
X-Large	75350

NITRILE GLOVES

- ▶ Pebble grip finish for maximum usability and comfort.
- ▶ Chemical-resistant, perfect for all treatment needs.
- ▶ 15 mil thick.

Sold in boxes of twelve

Green-Large	75500
Green-X-Large	75550



PARTICLE RESPIRATOR MASKS

- ▶ Offers protection when the job requires work around tiny particles.
- ▶ Adjustable nose clip ensures a more secure seal against the face.

Sold in boxes of twenty

Particle Mask	75200
---------------	-------

3M REUSABLE HALF FACE RESPIRATOR

- ▶ Reusable half-faced respirators offer comfort, convenience and cost savings.
- ▶ Respirator cartridges sold separately.

Medium	75250
Large	75275

3M RESPIRATOR CARTRIDGES

- ▶ Organic vapor/acid gas cartridge is NIOSH approved against certain organic vapors and gases.
- ▶ Swept-back design for enhanced field of view and balance.

Pack of two cartridges

Replacement Cartridges	75255
------------------------	-------

DISPOSABLE SPRAY SUITS

- ▶ Economical grey coveralls feature zipper front, open wrists and ankles.
- ▶ Three-layer fabric has cloth like polypropylene outside and web microfibers in the middle.

Sold in boxes of 25

Grey-Large	75400
Grey-X-Large	75450

BOLD. CRISP. CLEAR. GREEN AND RIGHT TO THE POINT!



GREEN LINE FAIRWAY SIGN

- ▶ Single-sided or double-sided signage with 5" (13 cm) galvanized screw-in stakes.
- ▶ Choice of two sizes: 9"H x 15"W (23 cm x 38 cm) or 6"H x 12"W (15 cm x 30 cm).
- ▶ Tough, long-lasting laminated material.
- ▶ Outstanding fade-resistance.
- ▶ For a little extra you can design your own sign. Email orders@StandardGolf.com.

GREEN/WHITE	Single-Sided	Single-Sided	Double-Sided	Double-Sided
	6"H x 12"W (15 cm x 30 cm)	9"H x 15"W (23 cm x 38 cm)	6"H x 12"W (15 cm x 30 cm)	9"H x 15"W (23 cm x 38 cm)
Carts On Path Only	09501	09901	09551	09951
Drop Area	09502	09902	09552	09952
Ground Under Repair	09503	09903	09553	09953
Keep Carts 30' From Green	09504	09904	09554	09954
No Carts	09505	09905	09555	09955
Please Repair Ball Marks	09506	09906	09556	09956
Replace Divots	09507	09907	09557	09957
Customized Sign	09598	09998	09599	09999

One-time Art Charge for Customized Sign 21300SS

GREEN LINE OVAL FAIRWAY SIGN

- ▶ 9" x 12" (23 cm x 30 cm) sign.
- ▶ Easy to read.
- ▶ Top handle allows for easy carry and removal.
- ▶ Single-sided and double-sided message options.

GREEN/WHITE	Single-Sided	Double-Sided
	9"H x 12"W (22.86 cm x 30 cm)	9"H x 12"W (22.86 cm x 30 cm)
No Carts	08101	08151
Keep Carts on Path	08102	08152
Carts Double Arrow	08103	08153
Mats Only	08104	08154
Irons Only	08105	08155
Ground Under Repair	08106	08156
Next Tee		08151
Drop Area		08152
Carts Single Arrow		08153
Scatter		08154
Range Closed		08155
Please Keep Off		08156

GREEN/WHITE	Single-Sided	Double-Sided
	9"H x 12"W (22.86 cm x 30 cm)	9"H x 12"W (22.86 cm x 30 cm)
Customized Sign	08198	08199

One-time Art Charge for Customized Sign 21300SS



GREEN LINE ARROW SIGN

- ▶ Double-sided, 13" (33 cm) long directional signs.
- ▶ For a little extra you can design your own sign. Email orders@StandardGolf.com.

One-time Art Charge for Customized Sign	21300SS
Customized Plastic Sign	10299

13" (33 cm) long

Carts	10200
Next Tee	10202
Golf Cars	10204



MADE TO ORDER
Don't see exactly what you want in this catalog? No problem. Email orders@StandardGolf.com to customize your order.

GREEN LINE PLASTIC SIGN

- ▶ Wide selection of horizontal 5"H x 10"W (13 cm x 25 cm) signage.
- ▶ For a little extra you can design your own sign. Email orders@StandardGolf.com.

5"H x 10"W (13 cm x 25 cm)

One-time Art Charge for Customized Sign	21300SS
---	---------

Single-Sided

Carts on Path Only	08715
No Golf Carts Beyond Here	08717
Please Repair Ball Marks	08719
Carts with Double Arrow	08722
Scatter (with arrows)	08723
90° Rule	08725
Driving Range Closed	08727
Keep Carts 30' From Green	08728
Ground Under Repair	08729
No Chipping	08731

Double-Sided

Ground Under Repair	08716
Please Keep Off	08718
Green Closed	08720
Carts (with single arrow)	08721
Drop Area	08724
Next Tee (with one way arrow)	08726
No Chipping	08730

CUSTOMIZED PLASTIC SIGN

Sign	Single-Sided	Double-Sided
	08798	08797

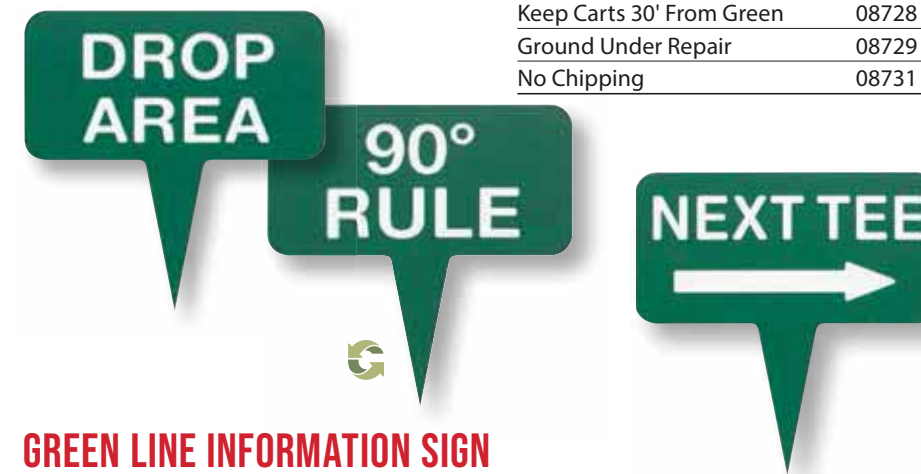

GREEN LINE INFORMATION SIGN

- ▶ 12" x 12" (30 cm x 30 cm) sign.
- ▶ Ready to mount. Outstanding durability.
- ▶ For a little extra you can design your own sign. Email orders@StandardGolf.com.

12"H x 12"W (30 cm x 30 cm)

In-Stock Information Sign (see right)	
Customized One-Color Image	10398-1
Customized Two-Color Image	10398-2
Customized Three-Color Image	10398-3
One-time Art Charge for Customized Sign	21300SS



FAIRWAY SIGN

- ▶ 4 1/2"H x 9"W (11 cm x 23 cm) signs.
- ▶ Includes two 5 1/2" (14 cm) stakes.
- ▶ Double-sided.

4 1/2"H x 9"W (11 cm x 23 cm)	GREEN/WHITE	GREEN
Carts On Path Only	09151	-
Drop Area	09152	-
Ground Under Repair	09153	-
Keep Carts 30' From Green	LIMITED SUPPLY 09154	-
No Carts	09155	-
Please Repair Ball Marks	LIMITED SUPPLY 09156	-
Replace Divots	LIMITED SUPPLY 09157	-
Plain/No Decals	-	09158



DIRECTION ARROW SIGN

- ▶ Includes two 9 1/2" (24 cm) galvanized screw-in stakes.
- ▶ Double-sided.

	WHITE/YELLOW		GREEN/WHITE	
	11" (28 cm)	15" (38 cm)	11" (28 cm)	15" (38 cm)
Carts	-	LIMITED SUPPLY 10000	10150	10050
Next Tee	LIMITED SUPPLY 10102	LIMITED SUPPLY 10002	10152	10052
Golf Cars	LIMITED SUPPLY 10104	-	10154	10054
No. ___ Tee	-	-	-	10056
Buggies	-	-	10160	10060
Trolleys	-	-	10162	10062



	WHITE		ORANGE	GREEN	
	11"H x 2 3/8"W (28 cm x 6 cm)	15"H x 4"W (38 cm x 10 cm)	11"H x 2 3/8"W (28 cm x 6 cm)	11"H x 2 3/8"W (28 cm x 6 cm)	15"H x 4"W (38 cm x 10 cm)
Plain/No Decals	10108	10008	10109	10158	10058

ALUMINUM INFORMATION SIGN

- ▶ 12" x 12" (30 cm x 30 cm).
- ▶ Single-sided. Silk-screened with weather-resistant ink.
- ▶ Order Sign Posts separately (see page 68).
- ▶ Provide artwork for signs not printed in English.
- ▶ Custom signs with multiple colors will incur additional costs.

12"H x 12"W (30 cm x 30 cm)

In-Stock Aluminum Information Sign (see below)

Erasable Aluminum Sign	10330
Customized Aluminum Sign*	10399
Customized Aluminum 2-Color Sign*	10399-2
One-time Art Charge for Customized Sign	2130055

*Minimum order for a custom sign is two signs.



*Part number 10302 is available with any hole number. A reversible arrow decal is included.

PLASTIC ENGRAVED SIGN

- ▶ 12" x 12" (30 cm x 30 cm).
- ▶ Pre-drilled holes are matched with our sign posts for easy mounting (see page 68).
- ▶ Consult your state regulatory commission to determine which sign you need.

12"H x 12"W (30 cm x 30 cm)

Plastic Engraved Sign – OH	10324OH
Plastic Engraved Sign – IA	10324IA
Custom Engraved Plastic Sign	10329

Plastic Engraved Signs



DON'T SEE EXACTLY WHAT YOU WANT? CUSTOMIZE IT!



If you don't see the sign you need on these pages, we'll customize one of our Aluminum or Green Line plastic signs for you. Just pick the size and style you would like and tell us what you want it to say.

ALUMINUM INFORMATION SIGN

- ▶ 6" x 12" (15 cm x 30 cm).
- ▶ Single-sided informational signs serve as helpful reminders to players and mount easily on single spike mounting base.
- ▶ Includes mounting base.
- ▶ Custom signs with multiple colors will incur additional costs.

6"H x 12"W (15 cm x 30 cm)

In-Stock Aluminum Information Sign	
Customized Aluminum Sign*	08599
One-time Art Charge for Customized Sign	21300SS

*Minimum order for a custom sign is two signs.



08510



08501



08504



08511

ONE-PIECE ALUMINUM SIGN

- ▶ 5" x 12" (13 cm x 30 cm).
- ▶ Single-sided, one-piece rust-free aluminum. Economical. Easy to use.
- ▶ Green, silk-screened lettering on a white background.

5"H x 12"W (13 cm x 30 cm)

Customized Aluminum Sign*	08799
One-time Art Charge for Customized Sign	21300SS

*Minimum order for a custom sign is two signs.



Carts on Paths Only	08702
Ground Under Repair	08705
No Golf Carts Beyond Here	08708
Please Keep Off	08709
Please Repair Ball Marks	08711

CLOCK-ON-POST

- ▶ Perfect for ranges or practice greens.
- ▶ Comes with sturdy stand alone support post which can be secured with spikes.
- ▶ Clock-On-Post features a 12" (30.5 cm) clock.
- ▶ Deluxe models feature 18" (45.7 cm) diameter atomic clock with built-in temperature and hydrometer gauges.
- ▶ Includes four ground spikes.
- ▶ Limited warranty.



Deluxe Clock-On-Post

	CLOCK-ON-POST 36"H x 4"W x 4"D (91 cm x 10 cm x 10 cm)	DELUXE CLOCK-ON-POST 48"H x 4"W x 4"D (122 cm x 10 cm x 10 cm)
Green	100115GN	100110GN
Brown	100115BR	100110BR
Black	100115BK	100110BK

REPLACEMENT CLOCK

- ▶ Weather-resistant.
- ▶ Two models:
 - 12" diameter (30.5 cm) Easel Replacement Clock.
 - 18" diameter (45.7 cm) Deluxe Easel Atomic Clock features built-in temperature and hydrometer gauges.
- ▶ Limited warranty.



12" (30.5 cm) Clock - White	200900
18" (45.7 cm) Atomic Clock - Silver	200902

SIX-YARDAGE EASEL (SINGLE-SIDED)

- ▶ Post up to six easy-to-read range flag distances with coordinated and customized flag colors.
- ▶ Larger model features 12" (30.5 cm) diameter clock.
- ▶ Includes six sets of numbers (0-8) for posting sign yardages.
- ▶ Limited warranty.
- ▶ Custom order. Allow 3-4 weeks.



	SIX-YARDAGE EASEL 32"H x 22"W (81 cm x 56 cm)	SIX-YARDAGE CLOCK EASEL 40"H x 32"W (102 cm x 81 cm)
Green	100130GN	100140GN
Brown	100130BR	100140BR
Black	100130BK	100140BK

EASEL CLOCK (SINGLE-SIDED)

- ▶ A striking addition to #1 and #10 tee boxes and clubhouse.
- ▶ Easel clock features a 12" (30.5 cm) clock.
- ▶ Deluxe model features 18" (45.7 cm) diameter atomic clock with built-in temperature and hydrometer gauges.
- ▶ Limited warranty.



	EASEL CLOCK 23"H x 16"W (58 cm x 41 cm)	DELUXE EASEL CLOCK 22"H x 28"W (56 cm x 71 cm)
Green	100100GN	100120GN
Brown	100100BR	100120BR
Black	100100BK	100120BK

TURFSTONE PERSONALIZED SIGN

- ▶ The look of granite.
- ▶ Durable.
- ▶ Crack- and fade-resistant.
- ▶ Hardware for horizontal and vertical mounting is included with sign.

9" x 12" (23 cm x 30 cm)

Gray Granite - One-Color Imprint	07199-1
Gray Granite - Two-Color Imprint	07199-2
Gray Granite - Three-Color Imprint	07199-3
Gray Granite - Four-Color Imprint	07199-4
Gray Granite - Five-Color Imprint	07199-5
Gray Granite - Six-Color Imprint	07199-6
Gray Granite - Seven-Color Imprint	07199-7

Add a photo-quality image to your TurfStone sign.

Photo Image Charge	10698
--------------------	-------

Optimize your TurfStone sign with a classic black frame.

TurfStone Sign Frame	67190
----------------------	-------



Honor a staff member or benefactor of your club when you add a photo-quality, laser engraved image to our 9" x 12" (23 cm x 30 cm) TurfStone signs.



PERMANENT & TEMPORARY SIGN POST

- ▶ Permanent posts can be removed and stored in the off-season.
- ▶ Temporary models can quickly be removed or repositioned.
- ▶ All hardware included.

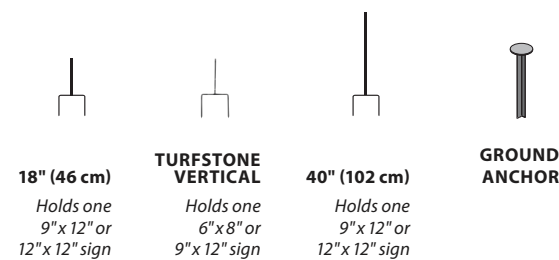

Permanent	-	-	-	36205
Temporary	10418	-	10400	-
TurfStone Stakes	-	10600	-	-



DELUXE SCRUSHER & SCRUSHER

- ▶ Three separate bottom brushes now with softer, longer-lasting nylon bristles.
- ▶ Two-sided brushes with gentler bristles that don't scratch the sides of shoes.
- ▶ The wider design of the Deluxe Scrusher offers more stability and extra space between lower bristles to prevent buildup.
- ▶ UV, environmentally safe, powder-coated finish included on the Deluxe model.
- ▶ Mounting stakes sold separately, four per unit (see below).

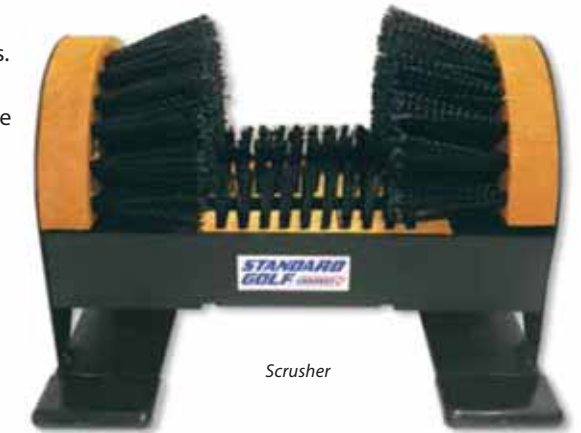

6 1/2" H x 22 1/4" W x 6" D (16.5 cm x 56.5 cm x 15.2 cm)

Bottom Replacement Brush – three needed	14102
Side Replacement Brush – two needed	14103
Scrusher	14100
Deluxe Scrusher	14000

MOUNTING STAKES

6" (15 cm) long

Asphalt Mounting Stake	14106
------------------------	-------

18" (46 cm) long

Turf Mounting Stake	14124
---------------------	-------



DELUXE SCRUSHER HANDLE

- ▶ Helps players maintain more stability and balance.
- ▶ Bolts securely to the underside of the Deluxe Scrusher (hardware included).

31 1/2" H x 10 1/2" W (80 cm x 27 cm)

Deluxe Scrusher Handle	14050
------------------------	-------



SPIKE KLEENER

- ▶ Efficient synthetic bristles. Durable, cast aluminum, powder-coated base.
- ▶ Includes four 3 1/2" (8.9 cm) stakes.



5 3/8" x 5 1/8" (14 cm x 13 cm)

Red	14350
Green	14450
Black	14750

5 3/8" x 5 1/8" (14 cm x 13 cm)

Replacement Brush	14252
-------------------	-------

DELUXE COMPRESSED AIR SHOE CLEANER

- ▶ Blows dirt and grass off shoes with compressed air.
- ▶ Traps clippings in an easy-to-remove tray.
- ▶ Deluxe model includes air wand.
- ▶ Air compressor housing sold separately.
- ▶ Air compressor is not included.
- ▶ Housing fits 2-horsepower, 2.6 gallon, 90 PSI air compressor (not included).

DELUXE COMPRESSED AIR SHOE CLEANER
38"H X 26"W X 22"D (97 cm x 66 cm x 56 cm)

Green	100190GN
Brown	100190BR
Black	100190BK

AIR COMPRESSOR HOUSING
24"H X 14"W X 22"D (61 cm x 36 cm x 56 cm)

Green	100199GN
Brown	100199BR
Black	100199BK



Air compressor housing

Housing can be placed next to the shoe cleaner unit.

ADD YOUR LOGO
SEE PAGE 20



DUO-KLEENER STAND

- ▶ Put this useful spike cleaner to work wherever it's needed most.
- ▶ Anchors in asphalt or in the ground with turf stakes.
- ▶ Includes stand, brushes, hardware and three 3 1/2" (9 cm) spikes.

Duo-Kleener Stand	36650
-------------------	-------

5 3/8" x 5 1/8" (14 cm x 13 cm)

Replacement Brush	14252
-------------------	-------

CONSOLE MOUNT WITH BRUSH

Console Mount with Brush	36156B
--------------------------	--------



VERTICAL POST MOUNT WITH BRUSH

Vertical Post Mount with Brush	14950
--------------------------------	-------



GREEN LINE TEE SIGNS AND POSTS



Curved

Deluxe

GREEN LINE TEE SIGN

- ▶ Stylish. Low maintenance. Weather-resistant tee signs.
- ▶ All signs include club logo, hole number, par, yardage with optional hole layout.
- ▶ Sign comes pre-drilled for easy installation. Please specify if you do not want the sign drilled when ordering.
- ▶ Green Line Mounting Post sold separately.
- ▶ Includes six color-matched mounting screws.

	CUSTOMIZED GREEN LINE CURVED SIGNS WITHOUT LAYOUT 23 1/2"H x 17 1/2"W x 1/2"D (60 cm x 44 cm x 1 cm)	CUSTOMIZED GREEN LINE DELUXE SIGNS WITHOUT LAYOUT 23 1/2"H x 17 1/2"W x 1/2"D (60 cm x 44 cm x 1 cm)	CUSTOMIZED GREEN LINE CURVED SIGNS WITH LAYOUT 23 1/2"H x 17 1/2"W x 1/2"D (60 cm x 44 cm x 1 cm)	CUSTOMIZED GREEN LINE DELUXE SIGNS WITH LAYOUT 23 1/2"H x 17 1/2"W x 1/2"D (60 cm x 44 cm x 1 cm)
Green/White	300705	300605	300700	300600
Black/White	300755	300655	300750	300650

GREEN LINE POST

- ▶ The perfect mounting option for our Green Line Tee Signs.
- ▶ Features decorative beveled top.

72" (183 cm) long, 4"W x 4"D (10 cm x 10 cm)

Green	300800GN
Black	300800BK

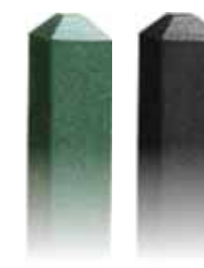

RECYCLED 4" X 4" CHAMFER POSTS **NEW!**

These recycled posts are a great look and finish to your tee signs or other course signage. The best part? The economical price and you are helping the environment.

RECYCLED 4" X 4" CHAMFER POSTS
4" x 4" x 72"
(10 cm x 10 cm x 183 cm)

Green	400800GN
Black	400800BK



5 DIFFERENT TEE CONSOLE PACKAGES

- ▶ Everything is included.
- ▶ All selections come with bold, black stands/posts.
- ▶ Each combination includes matching Ball Washer/Trash Receptacle.
- ▶ Granite-like TurfStone signage on select kits.

TRADITION TEE CONSOLE KIT 1

- ▶ Classic. Robust. Versatile.
- ▶ 19" (48 cm) cast aluminum base makes it easy to reposition to reduce wear and tear.
- ▶ Includes spikes to anchor it firmly into the ground.
- ▶ Includes Tradition Console Stand (Black) and your choice of a Premier or Medalist Ball Washer.



WITH MEDALIST BALL WASHER WITH PREMIER BALL WASHER

Red	39225	39125
Green	39250	39150
Black	39270	39170

TRADITION TEE CONSOLE KIT 2

- ▶ Classic. Robust. Versatile.
- ▶ 19" (48 cm) cast aluminum base makes it easy to reposition to reduce wear and tear.
- ▶ Includes spikes to anchor it firmly into the ground.
- ▶ Includes Tradition Console Stand (Black), your choice of a Premier or Medalist Ball Washer, plus matching single Litter Mate unit.



WITH MEDALIST BALL WASHER WITH PREMIER BALL WASHER

Red	39425	39325
Green	39450	39350
Black	39470	39370

TRADITION TEE CONSOLE KIT 3

- ▶ Classic. Robust. Versatile.
- ▶ 19" (48 cm) cast aluminum base makes it easy to reposition to reduce wear and tear.
- ▶ Includes spikes to anchor it firmly into the ground.
- ▶ Includes Tradition Console Stand (Black), your choice of a Premier or Medalist Ball Washer, plus matching double Litter Mate unit.



WITH MEDALIST BALL WASHER WITH PREMIER BALL WASHER

Red	39625	39525
Green	39650	39550
Black	39670	39570

JUNIOR TEE CONSOLE KIT

- ▶ Wide-stance tripod-style stand combines simplicity, utility, affordability; and it's built to last.
- ▶ Very portable. Easy to move around to minimize wear and tear in high-traffic areas.
- ▶ Screw-in spikes (included) anchor it firmly into the ground.
- ▶ Includes Junior Console Stand (Black) with a Classic Ball Washer and color-matched 9-gallon (34 L) Litter Caddie with spike.



WITH CLASSIC BALL WASHER

Red	39825
Green	39850
Black	39870

TURFSTONE TEE CONSOLE KIT

- ▶ Displays hole layout on rich granite-style TurfStone. (Up to ten colors.)
- ▶ Includes classy, laser-engraved TurfStone Tee Sign – 16" x 24" (41 cm x 61 cm).
- ▶ Includes 36" (91 cm) TurfStone Console Stand (Black), Classic Ball Washer (34 L) Litter Caddie with spike and ground anchor.



WITH CLASSIC BALL WASHER

Red	67825
Green	67850
Black	67870

BUILD TO SUIT

It's easy to customize the perfect tee console for your course. Simply follow steps one through four. Pick your stand. Then, configure it with the exact options you want for your tee boxes. All built-to-suit Tee Consoles will have a freight surcharge similar to pre-built Tee Consoles. **Want customized tee signage? Email orders@StandardGolf.com.**

1 PICK A STAND

GROUND ANCHOR	PERMANENT MOUNTING POST	JUNIOR TEE CONSOLE	TRADITION TEE CONSOLE	TURFSTONE TEE CONSOLE
18" (46 cm) Ground Anchor with Hardware 65205	48" (122 cm) Post 36248	Junior Console Stand 36200	Traditional Console Stand 36230	TurfStone Console Stand 65204
		 33" (84 cm) tripod base and post assembly	 19" (48 cm) cast aluminum base & 34" (86 cm) post	 37" (94 cm) post, ball washer bracket, Litter Caddie bracket and ground anchor

2 ADD A BALL WASHER

PREMIER BALL WASHER	MEDALIST BALL WASHER	CLASSIC BALL WASHER
Single Ball/Plunger-style	Single Ball/Plunger-style	Four Ball/Crank-style
Red 01425	Red 01525	Red 01325
Green 01450	Green 01550	Green 01350
Black 01470	Black 01570	Black 01370
		Yellow 01300
		Brown 01340
		Blue 01375



INSTALLATION

All washers mount on any Standard Golf ball washer or console stand or attach to any 2 3/8" (6 cm) O. D. post.

3 ADD A TRASH RECEPTACLE

LITTER MATE™

- Includes hardware and trash opening lids.
- 9-gallon (34 L) capacity per unit.
- Additional lids available (see page 83).
- Double unit comes with "cans" and "trash" lids.

	SINGLE	DOUBLE
Red	12842	12940
Green	12862	12960
Black	12892	12990

9-GALLON (34 L) LITTER CADDIE - WITH SPIKE

White	13100
Red	13150
Blue	13175
Yellow	13400
Green	13700
Black	13195

Not available on TurfStone Tee Console.

4 ADD A SPIKE BRUSH

TRADITION TEE CONSOLE	JUNIOR TEE CONSOLE
Replacement Brush 14252	Console Mount with Brush 36156B

A NEW LOOK AT TEE SIGNAGE

TurfStone Tee Signs give your course the look of granite at a fraction of the cost. They're also more durable than wood or synthetics because they're made with molded composite materials that resist cracking, fading, staining and chemicals.

EASY ORDERING

- Provide us with a scorecard or an architectural drawing of your layout and we'll take care of the rest.
- Allow three weeks for delivery after approval of color proofs.
- Easily mounts horizontally or vertically on 16" (41 cm), 26" (66 cm) or 36" (91 cm) posts.



Gray Granite

Horizontal

You can personalize your TurfStone™ with your hole layouts. Our precision laser system captures every detail and uses UV-resistant inks for a look that lasts for years. Available on both horizontal and vertical signs.

TURFSTONE TEE SIGNS	ONE-COLOR SIGN	TWO- OR THREE-COLOR SIGN	FOUR- TO TEN-COLOR SIGN
16" x 24" (41 cm x 61 cm)	post and anchor not included	post and anchor not included	post and anchor not included
<input type="checkbox"/> Gray Granite	65230	65220	65200

TURFSTONE SIGNAGE



	OPTIONAL DONOR SIGN
	9" x 12" (23 cm x 30 cm)
<input type="checkbox"/> Gray Granite - One-Color Imprint	07199-1
<input type="checkbox"/> Gray Granite - Two-Color Imprint	07199-2
<input type="checkbox"/> Gray Granite - Three-Color Imprint	07199-3
<input type="checkbox"/> Gray Granite - Four-Color Imprint	07199-4
<input type="checkbox"/> Gray Granite - Five-Color Imprint	07199-5
<input type="checkbox"/> Gray Granite - Six-Color Imprint	07199-6
<input type="checkbox"/> Gray Granite - Seven-Color Imprint	07199-7

Hardware for horizontal and vertical mounting is included with sign.

TURFSTONE TEE SIGN POST

Order ground anchors separately.

36" (91 cm) Post with Hardware	65236
--------------------------------	-------

GROUND ANCHOR

18" (46 cm) Ground Anchor with Hardware	65205
---	-------

THE MARK OF A CHAMPION COURSE

CENTENNIAL SERIES TEE MARKERS

Engraved tee markers are designed to impress.

- ▶ Available in bronze or aluminum.
- ▶ Double-sided and richly accented.
- ▶ Choose from a variety of color backgrounds.
- ▶ Design your own custom markers. Email orders@StandardGolf.com for more information.
- ▶ Set-up charge additional (Part # 21300PC) on orders of less than 50 pieces.



Customized product, allow 4 to 6 weeks production.

ALUMINUM with two 4" (10 cm) stainless steel spikes	VERTICAL RECTANGLE	RECTANGLE	VERTICAL OVAL	OVAL	ROUND	SQUARE	CREST
	4"x6" (10.2 cm x 15.2 cm)	6"x4" (15.2 cm x 10.2 cm)	4"x6" (10.2 cm x 15.2 cm)	6"x4" (15.2 cm x 10.2 cm)	5" (12.7 cm) diameter	5"x5" (12.7 cm x 12.7 cm)	4"x6" (10.2 cm x 15.2 cm)
Red	300130AL	300136AL	300142AL	300148AL	300154AL	300160AL	300166AL
White	300131AL	300137AL	300143AL	300149AL	300155AL	300161AL	300167AL
Blue	300132AL	300138AL	300144AL	300150AL	300156AL	300162AL	300168AL
Gold	300133AL	300139AL	300145AL	300151AL	300157AL	300163AL	300169AL
Black	300134AL	300140AL	300146AL	300152AL	300158AL	300164AL	300170AL
Green	300135AL	300141AL	300147AL	300153AL	300159AL	300165AL	300171AL

BRONZE with two 4" (10 cm) stainless steel spikes	VERTICAL RECTANGLE	RECTANGLE	VERTICAL OVAL	OVAL	ROUND	SQUARE	CREST
	4"x6" (10.2 cm x 15.2 cm)	6"x4" (15.2 cm x 10.2 cm)	4"x6" (10.2 cm x 15.2 cm)	6"x4" (15.2 cm x 10.2 cm)	5" (12.7 cm) diameter	5"x5" (12.7 cm x 12.7 cm)	4"x6" (10.2 cm x 15.2 cm)
Red	300130BZ	300136BZ	300142BZ	300148BZ	300154BZ	300160BZ	300166BZ
White	300131BZ	300137BZ	300143BZ	300149BZ	300155BZ	300161BZ	300167BZ
Blue	300132BZ	300138BZ	300144BZ	300150BZ	300156BZ	300162BZ	300168BZ
Gold	300133BZ	300139BZ	300145BZ	300151BZ	300157BZ	300163BZ	300169BZ
Black	300134BZ	300140BZ	300146BZ	300152BZ	300158BZ	300164BZ	300170BZ
Green	300135BZ	300141BZ	300147BZ	300153BZ	300159BZ	300165BZ	300171BZ

TRIAD TEE MARKER

- ▶ Sleek low-profile design. Ultra-durable.
- ▶ 100% recycled material.

TRIAD 2 1/2"H x 3 1/2"W (6 cm x 9 cm)	
Red	100030
White	100031
Blue	100032
Yellow	100033
Black	100035
Green	100039

5" (12.7 cm) spike



TILTED BLOCK TEE MARKER

- ▶ Simple square cube makes an attractive angular marker design.
- ▶ 100% recycled material.

TILTED BLOCK 3 1/2"H x 3 1/2"W (9 cm x 9 cm)	
Red	100010
White	100011
Blue	100012
Yellow	100013
Black	100015
Green	100019

5" (12.7 cm) spike

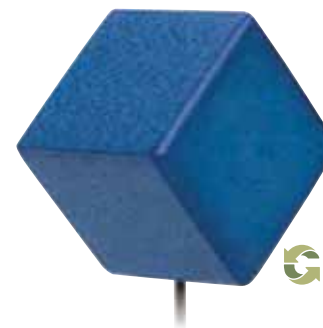

TOWER TEE MARKER

- ▶ Stacked, high-profile beveled tower design enhances any tee area.
- ▶ 100% recycled material.

TOWER 6"H x 4"W (15 cm x 10 cm)	
Red	100040
White	100041
Blue	100042
Yellow	100043
Black	100045
Green	100049

5" (12.7 cm) spike



STRUCTURED TEE MARKER

- ▶ Layered double-block style is built to last.
- ▶ 100% recycled material.

STRUCTURED 4 1/2"H x 4"W x 4"D (11 cm x 10 cm x 10 cm)	
Red	100020
White	100021
Blue	100022
Yellow	100023
Black	100025
Green	100029

5" (12.7 cm) spike



STANDARD TEE/ YARDAGE MARKER NEW!

- ▶ Made from a synthetic polymer for a lighter and more durable construction.
- ▶ Recessed center of the marker is perfect for adding specific distance or club/event logos.
- ▶ 4" diameter decals are available for Standard Yardage and Tee Markers (call for pricing).

RUBBER TEE/YARDAGE MARKER		
	6" (15.25 cm)	11" (27.94 cm)
Red	09010	09020
White	09011	09021
Blue	09012	09022
Yellow	09013	09023

5 1/2" (14 cm) spike



STEEL TEE DISTANCE MARKER

- ▶ Sharp, powder-coated 16-gauge steel construction.
- ▶ 1/2" (1.3 cm) lip.

STEEL 6 1/2" (16.5 cm) diameter	
Red	09250
White	09251
Blue	09252
Yellow	09253
Black	09255
Green	09259

5 1/2" (14 cm) spike



BRANCH TEE MARKER

- ▶ An old favorite. Natural, rustic look.
- ▶ Durable, heavy-resin material.

BRANCH

3"H x 2 3/4"W x 9 1/2"D (8 cm x 7 cm x 24 cm)

Red	05850
White	05851
Blue	05852
Yellow	05853
Black	05855
Green	05859

2" (5 cm) spikes

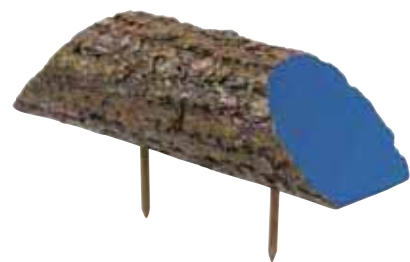
**LOG TEE MARKER**

- ▶ Compact and popular alternative to branch tee design.

LOG

4 1/4"H x 4"W (11 cm x 10 cm)

Red	05650
White	05651
Blue	05652
Yellow	05653
Black	05655

3 1/2" (9 cm) spike

**STEEL MARKER**

- ▶ Heavy-gauge steel.
- ▶ Powder-coated finish.

STEEL

5" (12.7 cm) diameter

Red	05200
White	05201
Blue	05202
Yellow	05203
Black	05205
Green	05209

5 1/2" (14 cm) spike

**PLAIN DIMPLE-T MARKER**

- ▶ The original. Most durable ever built.
- ▶ Favorite of golf courses worldwide.

DIMPLE-T

Plain

5" (12.7 cm) diameter

Red	05250
White	05251
Blue	05252
Yellow	05253
Black	05255
Silver	05256
Gold	05257
Orange	05258
Green	05259

4 1/2" (11 cm) spike

**PERSONALIZED DIMPLE-T MARKER**

- ▶ Personalize the classic Dimple-T Marker with your club logo.
- ▶ Decals priced separately.

DIMPLE-T

Personalized

5" (12.7 cm) diameter Decal: 3" (7.6 cm) diameter

Red	05270
White	05271
Blue	05272
Yellow	05273
Black	05275
Silver	05276
Gold	05277
Orange	05278
Green	05279

4 1/2" (11 cm) spike



See page 49
or email
orders@StandardGolf.com
for decal information.

WEDGE MARKER

- ▶ Molded low-profile design.
- ▶ Customize them with multi-colored logo design.
- ▶ Decals priced separately.

WEDGE

5"H x 4"W

(13 cm x 10 cm)

Red	05150
White	05151
Blue	05152
Yellow	05153
Black	05155
Green	05159

3" (8 cm) rear spike



See page 49
or email
orders@StandardGolf.com
for decal information.

DIRECTIONAL ARROW T-MARKER

- ▶ Each tee marker is powder-coated with a resilient and bright finish.
- ▶ Each sign includes two 5 1/2" (14 cm) galvanized screw-in stakes.

DIRECTIONAL ARROW

11"W x 2 3/8"H (28 cm x 6 cm)

Red	05050
White	05051
Blue	05052
Yellow	05053
Black	05055
Orange	05058
Green	05059

5 1/2" (14 cm) spike

**CROWN ALUMINUM MARKER**

- ▶ Ventilated design preserves tee grass.
- ▶ Powder-coated aluminum.

CROWN ALUMINUM

6" (15.2 cm) diameter 2" (5 cm) high

Red	05700
White	05701
Blue	05702
Yellow	05703
Black	05705
Green	05709
Pink	05710

**CLASSIC-T MARKER**

- ▶ One-piece, easy-to-handle design.
- ▶ Economical option, built to last.

CLASSIC-T

3 1/2" (8.9 cm) diameter

Red	05600
White	05601
Blue	05602
Yellow	05603
Black	05605
Orange	05608
Green	05609

3" (8 cm) spike

**CAST ALUMINUM MARKER**

- ▶ Powder-coated finish.
- ▶ For a little extra you can customize it with your logo. Email orders@StandardGolf.com.

CAST ALUMINUM

3 1/2" (8.9 cm) diameter

Red	05750
White	05751
Blue	05752
Yellow	05753
Black	05755
Green	05759

5 1/2" (14 cm) spike

**SAF-T MARKER**

- ▶ Aluminum cap and spike.
- ▶ Value-priced and virtually indestructible.

SAF-T PLASTIC

3 3/4" (9.5 cm) diameter

Red	05300
White	05301
Blue	05302
Yellow	05303

3 1/2" (9 cm) spike



RECYCLED BROKEN TEE CADDIE

Bigger drivers and longer tees mean more broken tees.

- ▶ Low-maintenance wire mesh bottom lets dirt and sand sift through.
- ▶ 100% recycled material endures for years.

6½"W x 8¼"L (17 cm x 21 cm)

Green	100600GN
Brown	100600BR
Black	100600BK

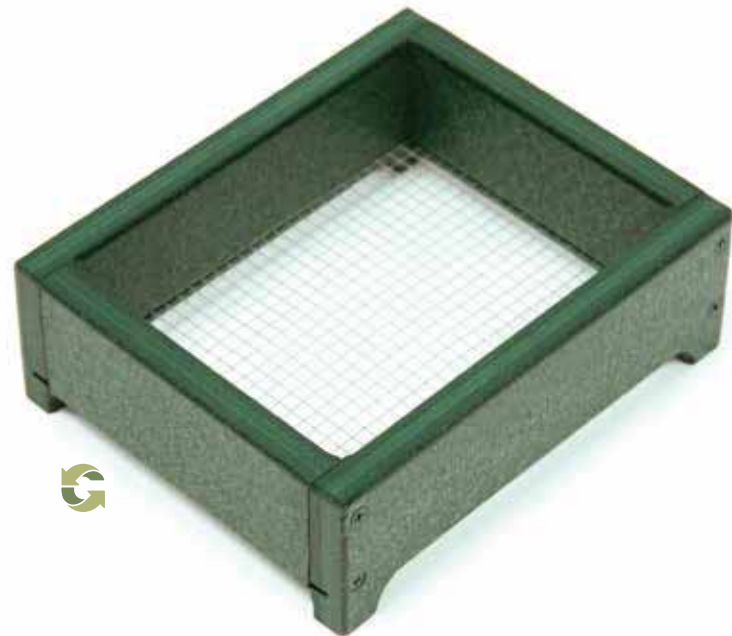

BROKEN TEE CADDIE

Sleek cone-shape design minimizes footprint.

- ▶ Powder-coated steel construction.
- ▶ Includes "Broken Tee" decal (not applied) and 5" (13 cm) spike.

6" H (15 cm) 5" (13 cm) spike

Black – White decal	19000
Yellow – Black decal	19015
Red – White decal	19025
Green – White decal	19050
Blue – White decal	19075
Orange – White decal	19085
White – Black decal	19095



TURFSTONE MARKER

- ▶ High-density plastic marker has the striking look and feel of granite at a fraction of the cost.
- ▶ Includes two 3½" (9 cm) plated steel rear spikes.
- ▶ For a little extra you can customize it with a one-color laser-engraved design in the color of your choice. Email orders@StandardGolf.com.

2¼"H x 5½"W x 6"D (6 cm x 14 cm x 15 cm)

Gray Granite – Plain	05806
----------------------	-------

Minimum order of nine markers required. Price per tee marker.

Additional Tee Marker Engraving Charge	05860
--	-------



MICROFIBER TEE TOWELS

Seven times the absorbency and three times the wicking power of cotton.

- ▶ Stain-, odor- and UV-resistant.
- ▶ Microfiber stays cleaner longer, dries faster, requires less maintenance.
- ▶ You can embroider them with your club logo.

18"H x 6"W tri-fold (46 cm x 15 cm)

Priced per dozen.

Black	–	04500
White	04502	–
Green	–	04503

Priced per dozen plus towel charge.

Embroidery	04290
------------	-------

One-time charge up to 8,000 stitches

Logo Tape Set-Up Charge	20990
-------------------------	-------



LARGE COTTON TOWELS

- ▶ Embroider or screen print with your club logo.

18"H x 6"W tri-fold (46 cm x 15 cm)

Priced per dozen.

White	04100
Green	04200

Priced per dozen plus towel charge.

Embroidery	04290
Screen Printing – One Color	04299

One-time charge up to 8,000 stitches

Logo Tape Set-Up Charge	20990
One-Color Art Charge	21300



WIZ DISPOSABLE TOWELS

LIMITED SUPPLY

- ▶ Absorbent and abundant.
- ▶ 200 per case.

24"H x 6"W duo-fold (61 cm x 15 cm)

White	04401
-------	-------



ECONOMY TEE TOWELS

- ▶ Stay well stocked, even on tight-fisted budgets.
- ▶ 200 per case.

21"H x 7"W duo-fold (53 cm x 18 cm)

Green/White	04969
-------------	-------

CHIX WASHABLE TEE TOWELS

- ▶ Absorbent and reusable.
- ▶ 200 per case.

21"H x 7"W duo-fold (53 cm x 18 cm)

Green	04970
-------	-------

CHIX DISPOSABLE TEE TOWELS

- ▶ Reinforced with nylon threads and tough metal eyelet.
- ▶ 200 per case.

21"H x 7"W duo-fold (53 cm x 18 cm)

Green/White	04965
-------------	-------



THE ORIGINAL TAPERED LITTER CADDIE

Perfectly shaped to properly contain trash contents.

- ▶ 20-gauge steel with rich, durable powder-coated finish.
- ▶ Select 9-gallon (34 L) and 30-gallon (114 L) sizes.

	9-GALLON (34 L)		30-GALLON (114 L)	
	4 3/4" (12 cm) spike	base	12" (30 cm) spike	base
Red	13150	13152	13050	13053
Blue	13175	13177	13080	13083
Yellow	13400	13500	13025	13028
Green	13700	13800	13075	13078
Black	13195	13197	13095	13098



VERTICAL MOUNT BRACKET

- ▶ Attaches 9-gallon (34 L) caddies to any 2 3/8" (6.0 cm) round post.

Vertical Mount Bracket	14901
------------------------	-------

CADDIE COVERS

- ▶ Durable polyethylene container top.
- ▶ Snaps onto 9-, 20- and 30-gallon (34 L, 76 L and 114 L) caddy.



Fits 9-gallon (34 L) Caddy	13190
Fits 20- (76 L) and 30-gallon (114 L) Caddy	13090

DECALS



4" W x 5/8" H
(10.2 cm x 1.6 cm)

9-GALLON (34 L)
fits both Litter Caddy and Litter Mate

Trash Only	13192
------------	-------

Sold in pairs.



Stainless Steel Webbing



STAINLESS STEEL LITTER CADDIE

Stainless ... the name says it all.

- ▶ 20-gallon (76 L) capacity, rust-proof caddy.
- ▶ Designed for long-life and easy bag removal.
- ▶ Use heavy-duty steel base or spikes for in-ground installations.

	20-GALLON (76 L)	
	12" (30 cm) spike	base
Red	13950	13953
Green	13975	13978
Black	13995	13998



SANDY SOIL CADDIE SPIKE

- ▶ For sandy/loose soil, a longer 10" (25 cm) spike is available for 9-gallon (34 L) Litter Caddy at no extra charge.

Sandy Soil Caddy Spike	13105
------------------------	-------

ACE TRASH CONTAINER

- ▶ 8-gallon (30 L) Trash Container.
- ▶ Attractive side panels dress up the range or tee area.
- ▶ UV-resistant material.
- ▶ Trash Container includes liners and lids.



ACE TRASH CONTAINER
16" w x 16" h x 19" d
(41 cm x 41 cm x 48 cm)

Green	12810
Brown	12820
Black	12830



LITTER MATE

- ▶ New thicker, stronger shell; accented with tough, molded black lid.
- ▶ Three lid options: solid, trash or can opening
- ▶ Mounts to any 2 3/8" (6 cm) post.
- ▶ Single units with lids include one liner and pole mounting hardware.
- ▶ Double units include one trash lid, one can lid, two liners and pole mounting hardware.
- ▶ 9-gallon (34 L) capacity per unit.
- ▶ Easy grip handles molded into side of Litter Mate.

MOUNTING & STANDS

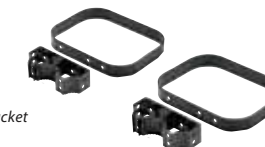

	LOW STAND	FLAT SURFACE MOUNT	SINGLE UNIT POLE MOUNT with hardware	DOUBLE UNIT POLE MOUNT with hardware
Complete Stand	12985	12986	-	-
Hoop Frame	-	-	12982	12982 x2
Pole Mounting Bracket	-	-	12983	12983 x2
Back Clamp	-	-	12984	-
Pole Mount Hardware	-	-	12988	12987 x1

LITTER CADDIE LINER

- ▶ Roll them up and snap them open inside to preserve clean, longer-lasting Litter Caddies.
- ▶ Flexible, black, polypropylene liners are easy to remove for cleaning.
- ▶ Include hole number, par and yardage by ordering a Tee Box Litter Caddy (9-gallon [34 L] size only). Available in white or orange numbers and letters.



	LITTER CADDIE LINER 9-gallon (34 L) Sold in sets of three	LITTER CADDIE LINER 20-gallon (76 L) Sold in sets of two	LITTER CADDIE LINER 30-gallon (114 L) Sold in sets of two	TEE BOX LITTER CADDIE LINER 9-gallon (34 L) Sold in sets of three
No Text	13850	13870	13860	-
White Text	-	-	-	13810
Orange Text	-	-	-	13820

NEW LOWER PRICE!

NEW AND IMPROVED LITTER MATE
WITH MORE LID OPTIONS, ALL AT A LOWER PRICE!

	SINGLE With trash lid	SINGLE With solid lid	SINGLE With cans lid	DOUBLE UNIT With trash and cans lid
Red	12842	12843	12844	12940
Green	12862	12863	12864	12960
Black	12892	12893	12894	12990

	TRASH LID ONLY	SOLID LID ONLY	CANS LID ONLY	CONTAINER ONLY
Red	-	-	-	12841
Green	-	-	-	12861
Black	12992	12993	12994	12891

5-GALLON (19 L) RECYCLED ROUND TRASH CONTAINER

Attractive and compact.

- ▶ 100% recycled plastic design.
- ▶ Includes removable liner and convenient lid.

17½"H x 14"W (44 cm x 36 cm)

Green	200100GN
Brown	200100BR
Black	200100BK



10-GALLON (38 L) RECYCLED SQUARE TRASH CONTAINER

Unparalleled durability.

- ▶ Heavy-duty construction. Low-profile.
- ▶ 100% recycled material.
- ▶ Includes liner and lid.

18½"H x 19"W x 19"D (47 cm x 48 cm x 48 cm)

Green	200150GN
Brown	200150BR
Black	200150BK



TRIPOD WATER STATION

Very practical. Very portable.

- ▶ Fold-up design is perfect solution for temporary water needs.
- ▶ Holds a 10-gallon (38 L) Igloo cooler (not included).
- ▶ Cooler Cover Lock (pg. 87) provides added protection.

39"H x 25"W (99 cm x 64 cm)

Green	200340GN
Brown	200340BR
Black	200340BK

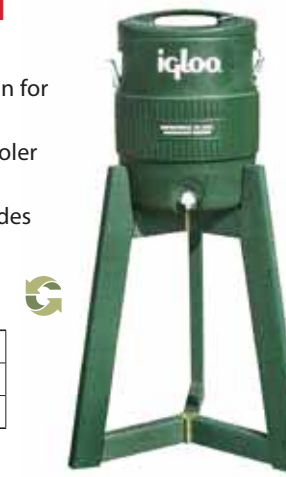

DELUXE TRIPOD WATER STATION

Our most popular Green Line station.

- ▶ Slatted container on foldable stand. Lockable and very portable.
- ▶ Holds 10-gallon (38 L) Igloo cooler (not included).

67½"H x 25"W (172 cm x 64 cm)

Green	200350GN
Brown	200350BR
Black	200350BK

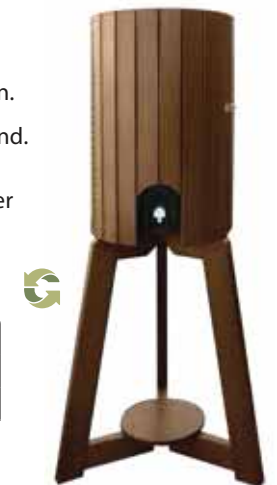

RECYCLED ROUND TRASH CONTAINERS

The bigger the container, the less you have to maintain.

- ▶ Sleek, stylish slatted design fits anywhere.
- ▶ 100% recycled material.
- ▶ Includes liner.

20-GALLON (76 L) 32-GALLON (121 L)
24"H x 19"W (61 cm x 48 cm) 33"H x 19"W (84 cm x 48 cm)

Green	200180GN	200190GN
Brown	200180BR	200190BR
Black	200180BK	200190BK



20-GALLON (76 L) RECYCLED SLATTED TRASH CONTAINER

Trash removal and maintenance made easy. Just lift the lid!

- ▶ Made from 100% recycled material.
- ▶ Attractive and built to last.
- ▶ Includes liner and lid.

24"H x 24"W x 24"D (61 cm x 61 cm x 61 cm)

Green	200160GN
Brown	200160BR
Black	200160BK



FULL ENCLOSURE WATER STATION

Same basic cooler as open-stand design in full length, fully enclosed housing.

- ▶ Holds 10-gallon (38 L) Igloo cooler (not included).
- ▶ Includes cup dispenser and convenient, self-closing trash door (liner included).

70"H x 27"W x 24"D (178 cm x 69 cm x 61 cm)

Green	200300GN
Brown	200300BR
Black	200300BK



OPEN BASE WATER STATION

Classy. Streamlined. Versatile.

- ▶ 4-post open-stand housing for 10-gallon (38 L) Igloo cooler (not included).
- ▶ Includes cup dispenser.
- ▶ Lockable for full enclosure water station.

70"H x 23"W x 23"D (178 cm x 58 cm x 58 cm)

Green	200320GN
Brown	200320BR
Black	200320BK



16-GALLON (61 L) RECYCLED SQUARE TRASH CONTAINER

A classy complement for tees or clubhouse areas.

- ▶ Attractive side paneling.
- ▶ Easy-open hinged lid for quick trash removal.
- ▶ Includes liner.

30"H x 16"W x 16"D (76 cm x 40 cm x 40 cm)

Green	200170GN
Brown	200170BR
Black	200170BK



26-GALLON (98 L) RECYCLED TRASH CONTAINER

Big-time capacity!

- ▶ Innovative, side-loading design for easy access.
- ▶ Includes liner.

43"H x 19"W x 19"D (109 cm x 48 cm x 48 cm)

Green	200200GN
Brown	200200BR
Black	200200BK



DELUXE DOUBLE WATER STATION

Designed for heavy traffic areas.

- ▶ Houses dual, 10-gallon (38 L) Igloo coolers (not included).
- ▶ Includes centrally-located cup dispenser.
- ▶ Two trash containers (liners included).
- ▶ Lockable for full enclosure water station.

71"H x 50"W x 24"D (180 cm x 127 cm x 61 cm)

Green	200310GN
Brown	200310BR
Black	200310BK



KOOLER-AID WATER STATION

Colorful. Rust-resistant. Place them anywhere!

- ▶ 10-gallon (38 L) Igloo cooler capacity stations.
- ▶ Choose one of our pre-configured kits or build your own.

WATER STATION KIT

Includes stand, tamper-safe top, Igloo water cooler and cup dispenser.

KOOLER-AID KIT
Includes 10-gallon (38 L) cooler

Green	45150
Black	45170
Red	45125

BUILD-YOUR-OWN KOOLER-AID WATER STATION

1 CHOOSE YOUR TOP

KOOLER-AID TOP
holds 10-gallon (38 L) cooler

Green	40151
Black	40171
Red	40126

2 CHOOSE YOUR STAND

KOOLER-AID STAND
with mounting tray

Black	40200
-------	-------

GROUND ANCHOR

18" (46 cm) Ground Anchor with Hardware	36205
---	-------

3 CHOOSE YOUR IGLOO WATER COOLER

10-GALLON (38 L)
Igloo water cooler

Green	45400
-------	-------

4 CUP DISPENSER

- ▶ Compatible with 4-oz (0.12 L) to 4.5-oz (0.13 L) rolled rim, cone-shaped paper cups. Includes lid.

Cup Dispenser	45600
---------------	-------

PAPER CUPS

- ▶ 4.25-oz (0.13 L) rolled rim cone-shaped cups.
- ▶ 5,000-quantity cases (25 sleeves of 200).

Case of 5,000	45650
---------------	-------



RECYCLED ICE CHEST CONTAINER

- ▶ Attractive, durable Green Line container blends in anywhere.
- ▶ Discreetly stores 54-quart ice chest (included).

24"H x 31 1/2"W x 19"D (61 cm x 80 cm x 48 cm)

Green	200360GN
Brown	200360BR
Black	200360BK



IGLOO WATER COOLER

- ▶ ABS construction. Ultratherm insulation.
- ▶ Long-lasting, thirst-quenching performance.
- ▶ Includes mounting bracket for cup holder.

10"D (25.4 cm) 17"H (43 cm)

5-Gallon (19 L)	48400
-----------------	-------

16 1/2"D (41.9 cm) 23"H (58 cm)

10-Gallon (38 L)	45400
------------------	-------

COOLER COVER LOCK

- ▶ Fight contamination head on.
- ▶ Fits 5- or 10-gallon (19 L or 38 L) Igloo Coolers.
- ▶ All locks keyed the same, so you can add more any time.

Cooler Cover Lock-Includes Padlock	45700
Padlock Only	45701

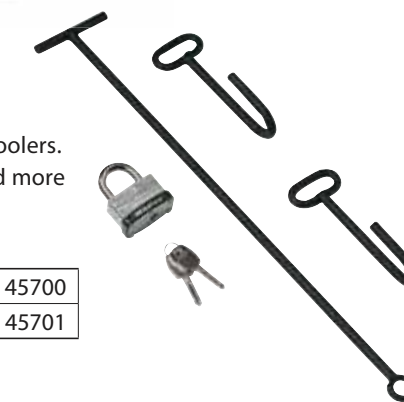

BRITA IGLOO COOLER FILTER

- ▶ Fits Igloo coolers.
- ▶ Great tasting water for less than a half cent per 4 oz cup.
- ▶ NSF certified to reduce chlorine taste and odor.
- ▶ BPA-free.
- ▶ 80 to 100 gallons without changing.
- ▶ Easily screws into place on inside of cooler.

Brita Filter 4-pack	49005
Adaptor	49006



LIMITED SUPPLY

FORCE-FLEX HAZARD/YARDAGE MARKER

- ▶ Flexible hazard/yardage marker.
- ▶ One piece, no sleeve or cap to replace.
- ▶ Drive over with carts and mowers in any direction and the Force-Flex will bounce back up every time.
- ▶ UV-resistant rod will not fade in the sun.
- ▶ Do not use without a ground anchor.
- ▶ Ground anchor sold separately.
- ▶ Works best with reel deck mowers.

19" (48 cm) long, plus 7" (18 cm) spike

	Single	Set of Twelve
White	15601	15600
Yellow	15701	15700
Red	15801	15800
Blue	15901	15900



PREMIUM GREEN LINE YARDAGE MARKERS

- ▶ Premium recycled plastic stakes feature a decorative beveled top and rich vibrant UV-resistant colors.
- ▶ 5 1/2" (14 cm) zinc-coated hardened steel spike makes it easy for players to remove and replace.
- ▶ **Sold in multiples of twelve.**



5 1/2" (14 cm) spike

	18" (46 cm) SQUARE with spike	24" (61 cm) SQUARE with spike
White	17018	17024
Yellow	17118	17124
Red	17218	17224
Blue	17318	17324



PVC DISTANCE MARKER

- ▶ For a sharp, more visible look.
- ▶ Easy to install with 7" (18 cm) PVC ground anchor and driving tool, not included (see below).
- ▶ Includes cap and decal.



32" (81 cm) long
Round: 1 1/2" (3.8 cm) diameter

	100	150	200	250
White/Red	09310	-	-	-
White/Black	-	09320	-	-
White/Blue	-	-	09330	-
White/Yellow	-	-	-	09340
Yellow/Black	-	09350	-	-

STEEL FAIRWAY DISTANCE MARKER

- ▶ Rich, powder-coated 11" (27.9 cm) diameter steel discs.
- ▶ Slightly curved for improved and discreet visibility.
- ▶ Includes 9 1/2" (24 cm) steel spike.



11" (27.9 cm) diameter

Red	09200
White	09201
Blue	09202
Yellow	09203



PVC GROUND ANCHOR

- ▶ For installation of PVC distance marker.

Round: 7" (18 cm) long, Inside diameter: 1.59" (4.06 cm)
Square: 4" (10 cm) long, Inside dimensions: 1.61" x 1.61" (4.09 cm x 4.09 cm)

Round	16157
Square	16575



DRIVING TOOL

48" (122 cm) long

Round	16158
-------	-------



FAIRWAY MARKING POLE

- ▶ 60" (152 cm) long, 1 1/2" (3.8 cm) diameter poles. Heavy-duty PVC pipe.
- ▶ 10" (25 cm) deep, 2" (5.1 cm) diameter ground anchor included.



60" (152 cm) long 1 1/2" (3.8 cm) diameter

Fairway Marking Pole	09700
Special Colored Stripe	09799

Ground Anchor

REMOVABLE RECYCLED PLASTIC STRIPED DISTANCE MARKERS

- ▶ Approved by German Golf Federation.
- ▶ 32" (81 cm) long, 1 1/2" (3.8 cm) diameter markers. UV-resistant to prevent cracking, rotting and moisture absorption.
- ▶ **Sold in multiples of twelve.**

Round: 1 1/2" (3.8 cm) diameter 32" (81 cm) ROUND

One Stripe (100 m)	09360
Two Stripes (150 m)	09370
Three Stripes (200 m)	09380



RECYCLED PLASTIC YARDAGE MARKERS - REMOVABLE

- ▶ Secure in a fixed position with PVC ground anchor.
- ▶ Molded with UV-resistant colors; won't crack, rot or absorb moisture.
- ▶ **Sold in multiples of twelve.**



Round: 1 1/2" (3.8 cm) diameter

	32" (81 cm) ROUND
White	16700
Yellow	16725
Red	16750
Blue	16775



RECYCLED PLASTIC YARDAGE MARKERS - WITH SPIKES

- ▶ Molded with UV-resistant colors; won't crack, rot or absorb moisture.
- ▶ 5" (13 cm) steel spike makes it easy for players to remove and replace.
- ▶ **Sold in multiples of twelve.**



5" (13 cm) spike
Round: 1 1/2" (3.8 cm) diameter

	24" (61 cm) ROUND with spike
White	16600
Yellow	16625
Red	16650
Blue	16675



STANDARD TEE/YARDAGE MARKER

- ▶ New and Improved tee and yardage marker that will not harm mowers. This rubber textured product has UV stabilizers and color fast throughout. Will not show different color if cut and will not chip.
- ▶ Made from a synthetic polymer for a lighter and more durable construction.
- ▶ Recessed center of the marker is perfect for adding specific distance or club/event logos.
- ▶ 4" diameter decals are available for Standard Yardage and Tee Markers (call for pricing).

NEW!

RUBBER TEE/YARDAGE MARKER
6" (15.25 cm) 11" (27.94 cm)

Red	09010	09020
White	09011	09021
Blue	09012	09022
Yellow	09013	09023

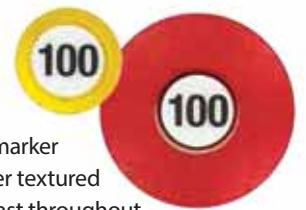

5 1/2" (14 cm) spike

CENTENNIAL SERIES YARDAGE MARKER

Add class, sophistication and durability to your fairway and tee box settings.

- ▶ Bronze or aluminum treatments come with a wide variety of rich color backgrounds.
- ▶ Choose rectangular, square or round styles for tees.
- ▶ Custom logos available. Set-up charge additional (Part #21300) on orders of less than less than 50 pieces.



Square Round
Customized product, allow 4 to 6 weeks for production.

ALUMINUM

	RECTANGLE with two 2 1/2" (6 cm) zinc-plated, threaded studs 7" x 5" (17.8 cm x 12.7 cm)	RECTANGLE 8" x 6" (20.3 cm x 15.2 cm)	ROUND 6" (15.2 cm) diameter 2 1/4" (5.7 cm) numbers	SQUARE 6" x 6" (15.2 cm x 15.2 cm) 2 1/4" (5.7 cm) numbers
Red	300100AL	300106AL	300112AL	300118AL
White	300101AL	300107AL	300113AL	300119AL
Blue	300102AL	300108AL	300114AL	300120AL
Gold	300103AL	300109AL	300115AL	300121AL
Black	300104AL	300110AL	300116AL	300122AL
Green	300105AL	300111AL	300117AL	300123AL

BRONZE

	RECTANGLE with two 2 1/2" (6 cm) zinc-plated, threaded studs 7" x 5" (17.8 cm x 12.7 cm)	RECTANGLE 8" x 6" (20.3 cm x 15.2 cm)	ROUND 6" (15.2 cm) diameter 2 1/4" (5.7 cm) numbers	SQUARE 6" x 6" (15.2 cm x 15.2 cm) 2 1/4" (5.7 cm) numbers
Red	300100BZ	300106BZ	300112BZ	300118BZ
White	300101BZ	300107BZ	300113BZ	300119BZ
Blue	300102BZ	300108BZ	300114BZ	300120BZ
Gold	300103BZ	300109BZ	300115BZ	300121BZ
Black	300104BZ	300110BZ	300116BZ	300122BZ
Green	300105BZ	300111BZ	300117BZ	300123BZ

CART ID FLAG

- ▶ Silk-screened ID flags for carts.
- ▶ Also includes heavy-duty squeeze clamps to attach to cart.



28" (71 cm) long 5 1/2"H x 8"W (14 cm x 20 cm) flag

Red	Players Assistant	09801
Blue	Disabled Symbol	09802
Red	Marshal	09803

PROXIMITY MARKER

- ▶ Durable. Easy-to-read. Ideal for "Long Drive" and "Proximity" contests.
- ▶ Four markers w/pencil holders and four packs of cards come with each set.
- ▶ 26" (66 cm) tall, pad area is 8" x 5" (20.3 cm x 12.7 cm).

26"H x 8"W x 5"D (66 cm x 20.3 cm x 12.7 cm)

Proximity Marker Set	10700
----------------------	-------

5"W x 8"H (12.7 cm x 20.3 cm)

Replacement Card Packs 25 cards per pack	10701
---	-------



CENTENNIAL SERIES PYRAMID YARDAGE MARKER

- ▶ Available in standard yardages (100,150,200,250).
- ▶ Includes two 2 1/2" (6 cm) zinc-plated, threaded studs.



Customized product, allow 4 to 6 weeks for production.

	PYRAMID (ALUMINUM) 9" x 5 1/4" (22.8 cm x 13.3 cm) 2 1/4" (5.7 cm) numbers	PYRAMID (BRONZE) 9" x 5 1/4" (22.8 cm x 13.3 cm) 2 1/4" (5.7 cm) numbers
Red	300124AL	300124BZ
White	300125AL	300125BZ
Blue	300126AL	300126BZ
Gold	300127AL	300127BZ
Black	300128AL	300128BZ
Green	300129AL	300129BZ

GREEN LINE YARDAGE MARKER

- ▶ Durable Green Line yardage markers in three distinct styles.
- ▶ Includes spike.
- ▶ Customized to your yardage.



	ROUTED ROUND 8" (20.3 cm)	ROUTED RECTANGULAR 8" x 12" (20 cm x 30 cm)	LARGE ROUTED ROUND 15" (38.1 cm)
Red (White numbers)	100080	100070	100090
White (Black numbers)	100081	100071	100091
Blue (White numbers)	100082	100072	100092
Yellow (Black numbers)	100083	100073	100093
Black (White numbers)	100085	100075	100095
Green (White numbers)	100089	100079	100099

MICROFIBER TWO-PIECE BAG TOWELS

- ▶ No odors. No stains. And UV-resistant.
- ▶ Seven times the absorbency of cotton.
- ▶ Smaller Velcro-attached towel can go with players to the green.
- ▶ Tri-folds to 6" x 24" (15 cm x 61 cm).
- ▶ **Priced per dozen.**

24"H x 6"W tri-fold (61 cm x 15 cm)

Red	04600
White	04602



FLAGSTICK STAND

- ▶ Perfect for displaying flagsticks indoors.
- ▶ Powder-coated steel for increased durability.
- ▶ Stand can be mounted for temporary or permanent use.



2 1/4"H x 7 1/2" Diameter (6 cm x 19.1 cm)

Flagstick Stand	26800
-----------------	-------

THINK PINK

CUSTOM EVENT FLAGS

- ▶ Every flag can be customized!
- ▶ Minimum order of nine.
- ▶ Simply email your artwork to orders@StandardGolf.com to see if you qualify for FREE artwork setup; better yet give us a call at 1-866-743-9773.
- ▶ Cloth tube design lays flat; ideal for framing.
- ▶ Available on white polyester only.
- ▶ Limited 30-day warranty.



19 7/8" x 13 3/8" (50.5 cm x 35.2 cm)	Single	Set of Nine
White Customized Event Flag	25652	25650

Each event flag design can be customized.



ALUMINUM CUP

- ▶ Unbeatable chip-resistant finish.
- ▶ Meets all USGA / R&A regulations.

6" (15 cm) high 4 1/4" (10.8 cm) diameter

Aluminum Cup	18303P
--------------	--------



ST2000 SMART-FIT CUP

- ▶ Notched-ferrule flagsticks fall right into place every time without twisting, sticking or sinking.
- ▶ Meets all USGA regulations.

6" (15 cm) high 4 1/4" (10.8 cm) diameter

Aluminum ST2000 Cup	18333P
---------------------	--------

Not compatible with grooved ferruled flagsticks.

ROYALINE FLAGSTICK

- ▶ Our most popular, economical flagstick for years ... and the favorite of golf courses everywhere.
- ▶ Ultra-strong, resilient, solid fiberglass construction.

1/2" (1.3 cm) diameter from top to bottom. 7 1/2" (2.3 m) 7 1/2" (2.3 m)

Pink	-	26107
White/Pink Stripe	26108	-

PINK FLAGS DUPONT SOLARMAX NYLON

- ▶ These pink flags are a perfect addition to any breast cancer event.

200 Denier	Single	Set of Nine
Pink Tube Lock	22422T	22420T

200 Denier	Single	Set of Nine
Pink/White Checked Tube Lock	22572T	22570T

CROWN ALUMINUM TEE MARKER

- ▶ Ventilated design preserves tee grass.
- ▶ Pink powder-coated aluminum.

6" (15 cm) diameter 2" (5 cm) high	Single	Set of Nine
Pink	05710	



SPECIAL EVENT CUP

- ▶ Pink, powder-coated steel cup in 6" (15.2 cm) and 8" (20.3 cm) sizes. Also available in pink plastic.
- ▶ Shorter-depth 8" (20.3 cm) cup is easily installed with our 8" (20.3 cm) Pro II Hole Cutter.

6" (15 cm) high	Single	Set of Nine
6" (15.2 cm) Steel Cup	18600P	

3" (8 cm) high	Single	Set of Nine
8" (20.3 cm) Steel Cup	18700P	

3" (8 cm) high	Single	Set of Nine
8" (20.3 cm) Plastic Cup	18775P	

LIMITED SUPPLY

PARTS LIST

BALL WASHERS P. 8 - 9

Century Model Case Parts	
01203	Lid
01205	Top Gasket
01213	Screw for Top (1)
01214	Hinge Pin
01215	Hinge Clip
01306	Drain Plug Wrench
01317	Set Screw (1)
01320	Towel Snap
01327	Drain Plug Gasket
01328	Drain Plug

Century Model Internal Parts	
01245	Nylon Blind End Crank Bushing
01311	Open End Bearing w/ Crank O-Ring and Insert
01321	Cartridge Half (1)
01323	Bumper (1)
01324	Crank O-Ring
01331	Bearing O-Ring
01332	Fiber Gasket (1)
01333	Locknut
01342	Impeller
01346	Impeller Set Screw
01347	Side Brush-New
01348	Race Brush-New

Classic Model Case Parts	
01302	Top
01303	Lid
01306	Drain Plug Wrench
01313	Screw for Top (1)
01314	Hinge Pin
01317	Set Screw (1)
01320	Towel Snap
01327	Drain Plug Gasket
01328	Drain Plug
01301	Case-Yellow
01326	Case-Red
01341	Case-Brown
01351	Case-Green
01371	Case-Black
01376	Case-Blue
01396	Case-White
01352	Plastic Overflow Tube

Classic Model Internal Parts	
01311	Open End Bearing w/ Crank O-Ring and Insert
01318	Blind End Bearing
01321	Cartridge Half (1)
01323	Bumper (1)
01324	Crank O-Ring
01331	Bearing O-Ring
01332	Fiber Gasket (1)
01333	Locknut
01342	Impeller
01343	Cartridge Assembly (Impeller, 2 Bumpers, Race Brush, 2 Side Brushes, 2 Cartridge Halves)
01344	Crank-Classic Ball Washer

01346	Impeller Set Screw
01347	Side Brush-New
01348	Race Brush-New

Premier & Medalist	
01317	Set Screw (1)
01320	Towel Snap
01401	Agitator Assembly-Also Fits Par Aide, R&R and Bayco Ball Washers
01402	Cup & Brush Assembly-Also Fits Par Aide, R&R and Bayco Ball Washers
01405	Lid Gasket (Premier Only)
01406	Stainless Steel Screw for Lid & Cup
01407	Stainless Steel Flat Washer for Lid & Cup
01408	Screw for Lid & Case
01410	Drain Plug
01411	Drain Plug Gasket
01412	Cup with Grommet
01413	Cup Brush Only
01416	Drain Plug Wrench
01514	5/32" Allen Key
01515	3/16" Allen Key
01517	5/16" x 3/4" (M8-1.25) Set Screw
01426	Body-Premier-Red
01427	Cover-Premier-Red
01451	Body-Premier-Green
01452	Cover-Premier-Green
01471	Body-Premier-Black
01472	Cover-Premier-Black
01526	Body-Medalist-Red
01527	Cover-Medalist-Red
01551	Body-Medalist-Green
01552	Cover-Medalist-Green
01571	Body-Medalist-Black
01572	Cover-Medalist-Black

Ashtray	
01432	Ashtray Holder Only

BUNKER RAKES P. 10 - 13

Duo & Tour Smooth II Bunker Rakes	
11204	Cone Only
11205	54" (137 cm) Natural Aluminum Handle-Duo/Tour Smooth/Tour Smooth II/Tour Pro w/Grip
11206	7/8" (2.2 cm) Rake Handle Grip-Aluminum Handle
11207	15/16" (2.4 cm) Rake Handle Grip-Composite and Ultralight Handles
11208	Bolt Only
11214	54" (137 cm) Tan Composite Handle-Duo/Old Style Tour Smooth w/Grip <small>LIMITED SUPPLY</small>
11216	54" (137 cm) Green Composite Handle-Duo/Old Style Tour Smooth w/Grip <small>LIMITED SUPPLY</small>
11217	Sleeve-15/16" (2.4 cm) Composite Handle for Duo
11501	15" (38 cm) Duo-Rake Head
11502	Bolt Assembly (Bolt and Cone)
11503	Anti-Seize Lubricant
11515	54" (137 cm) Yellow Aluminum Handle-Duo/Tour Smooth/Tour Smooth II/Tour Pro w/Grip
11516	54" (137 cm) Green Aluminum Handle-Duo/Tour Smooth/Tour Smooth II/Tour Pro w/Grip
11532	64" (163 cm) Gold Aluminum Curved Handle-Duo/Tour Smooth/Tour Smooth II/Tour Pro w/Grip
11542	64" (163 cm) Green Aluminum Curved Handle-Duo/Tour Smooth/Tour Smooth II/Tour Pro w/Grip

12205	72" (183 cm) Green Composite Handle-Duo/ Old Style Tour Smooth w/Grip
-------	--

Chief Rake, Tour Pro & Tour Smooth II Bunker Rakes

11200	60" (152 cm) Green Gator Grip Handle- Tour Smooth II/Tour Pro w/Grip
11201	60" (152 cm) Brown Gator Grip Handle Tour Smooth II/Tour Pro w/Grip
11210	72" (183 cm) Green Gator Grip Handle- Tour Smooth II/Tour Pro w/Grip
11211	72" (183 cm) Brown Gator Grip Handle- Tour Smooth II/Tour Pro w/Grip
11206	7/8" (2.2 cm) Rake Handle Grip
11901	20" (51 cm) Chief Rake Head
11701	20" (51 cm) Tour Pro-Head
11771	25" (64 cm) Tour Pro-Head
11710	54" (137 cm) Green Composite Handle- Tour Smooth II/Tour Pro w/Grip
11801	15" (38 cm) Tour Smooth II-Head
12202	22" (56 cm) Tour Smooth II-Head
11810	Mounting Screw-Tour Smooth II/Tour Pro
11811	End Cap-Composite and Gator Grip Handles

Tour Lite, Cart & Economy Bunker Rakes

11601	Economy Rake Head Only
11605	Economy Yellow Wood Rake Handle
11626	Economy Green Wood Rake Handle
12301	Tour-Lite/Cart Rake Head
12305	54" (137 cm) Yellow Ultralight Steel Handle w/Grip
12306	54" (137 cm) Green Ultralight Steel Handle w/Grip

CLUB WASHERS

P. 14

Range Mate Club Washer

01651	Bucket with Lid-Green Granite
01602	Brush (each)
01603	Brush Bracket
01605	Wire Stand

Recycled Club Washer

200915	Hand Brush-Club Washers
--------	-------------------------

CUPS

P. 15 - 18

Sand Cup

18401	Inner Shell
18402	Outer Shell
18823	Footgolf Support Stand

DIVOT MIX STORAGE

P. 19 - 22

Seed & Soil Caddie

18801	Tee Caddie Holder Only-Black
18901	Tee Caddie Holder Only-Green
18802	Tee Caddie Bottle with Lid
18803	Lid Only for Tee Caddie Bottle
18804	Decal Only
18805	Tee Caddie Bottle Only
13104	4-3/4" (12 cm) Spike Only
18890	Quad Soil Caddie
18951	Cart Caddie Holder
18952	Cart Caddie Bottle with Lid
18953	Cart Caddie Hardware
18954	Lid Only for Cart Caddie Bottle

Junior Seed & Soil Butlers

18942	Usage Decals-Set of 4
18943	4 oz (0.1 L) Hand Scoop
12985	Low Stand for Jr. Seed & Soil Butler
12986	Wall Mount Bracket

Seed & Soil Butlers

18971	Bucket with Lid-Hunter Green
18962	8 oz (0.2 L) Black Scoop
01605	Wire Stand

Green Line Divot Mix Storage

200928	Clear 16 oz (0.47 L) Scoop for Green Line Divot Mix Containers
18963	Black Hand Scoop w/Silver Standard Golf Logo (4 oz.-0.1 L)
200925BK	Lid-3.5 Gallon Round Slatted-Black
200925BR	Lid-3.5 Gallon Round Slatted-Brown
200925GN	Lid-3.5 Gallon Round Slatted-Green
200926BK	Lid-5 Gallon Round Slatted-Black
200926BR	Lid-5 Gallon Round Slatted-Brown
200926GN	Lid-5 Gallon Round Slatted-Green
200927BK	Lid-10 Gallon Round Slatted-Black
200927BR	Lid-10 Gallon Round Slatted-Brown
200927GN	Lid-10 Gallon Round Slatted-Green

FIXTURES AND BENCHES

P. 23

200918BK	High Back Bench Leg-Black
200918BR	High Back Bench Leg-Brown
200918GN	High Back Bench Leg-Green
200919BK	Bench Leg-Black
200919BR	Bench Leg-Brown
200919GN	Bench Leg-Green
200920BK	2" x 4" x 48" (5 cm x 10 cm x 122 cm) Bench Slat-Black
200920BR	2" x 4" x 48" (5 cm x 10 cm x 122 cm) Bench Slat-Brown
200920GN	2" x 4" x 48" (5 cm x 10 cm x 122 cm) Bench Slat-Green
200921BK	2" x 4" x 72" (5 cm x 10 cm x 183 cm) Bench Slat-Black
200921BR	2" x 4" x 72" (5 cm x 10 cm x 183 cm) Bench Slat-Brown
200921GN	2" x 4" x 72" (5 cm x 10 cm x 183 cm) Bench Slat-Green
200922	Bench Hardware-1 Bolt, 1 Washer, 1 Plastic Bolt Cover

FLAGS

P. 28 - 29

25700	200 Denier Polyester Flag-White- Grommet-Set of 9
-------	--

FLAGSTICKS

P. 32 - 34

26411	Tip
26412	Acorn Nut

EasyMark System

26700	Tap in Flagstick Holder w/ 1/2" (1.3 cm) diameter
26701	Spotter Ring for Tap in Anchor
26725	1/2" x 60" (1.3 cm x 152 cm) Rod-Red

HAZARD MARKERS

P. 36 - 37

Directional Stakes

15001	All-Flex Hazard/Yardage Marker Sleeve-White
15101	All-Flex Hazard/Yardage Marker Sleeve-Yellow
15201	All-Flex Hazard/Yardage Marker Sleeve-Red
15301	All-Flex Hazard/Yardage Marker Sleeve-Blue
15401	All-Flex Hazard/Yardage Marker Sleeve-Purple
15002	All-Flex Stake
15003	All-Flex Cap
16926	Directional Stake Colored Caps-Yellow
16936	Directional Stake Colored Caps-Green
16946	Directional Stake Colored Caps-Orange

16951	Directional Stake Colored Caps-Red
16976	Directional Stake Colored Caps-Blue

Plastic Hazard Marker Caps and Plug

16154	Marker Cap-White
16155	Marker Cap-Yellow
16156	Marker Cap-Red
16201	Plug with Spike

HOLE CUTTERS AND SHELLS

P. 38 - 39

Turfmaster Hole Cutter

28100	Bottom Cage Assembly (Less Blades)
28101	Handle Assembly w/Rubber Grips

Pro II and Magnum Hole Cutters

28204	Wood Handle
28704	Insert Assembly-Pro II
28715	Expeller Assembly-Pro II 4-1/4" (10.8 cm) Hole Cutter
28778	Expeller Assembly-Pro II 6" (15.2 cm) Hole Cutter
28788	Expeller Assembly-Pro II 8" (20.3 cm) Hole Cutter
28907	Insert Assembly-Magnum
28908	Ejector Push Rod-Magnum
28909	Ejector Handle Assembly-Magnum
28915	Expeller Assembly-Magnum 4-1/4" (10.8 cm) Hole Cutter

MAINTENANCE & TURF TOOLS

P. 40 - 45

Debris Rake

11301	21" (53 cm) Head-Debris Rake
11351	9" (23 cm) Head-Debris Rake
11310	Tine w/Nut & Bolt
11355	Fiberglass Handle w/Rubber Grip

Greenskeeper

27201	Body w/Handle
27202	Floor Plate
27203	Spring
27204	Spring Seat
27205	Finger (1)
27206	Roll Pin (1)
27207	Snap Ring (1)
27208	Handle

Turf Doctor

29201	Replacement Blade (each)
-------	--------------------------

Levelawn, Bunker Debris Sieve

29301	6' (1.8 m) Wood Handle
29302	30" (76 cm) Levelawn Head w/Hardware
29326	1/2" (1.3 cm) Bunker Sieve Head
29351	1/4" (0.6 cm) Bunker Sieve Head
29352	Bunker Debris Sieve Bracket Only
29377	36" (91 cm) Levelawn Head w/Hardware

Irrigation Head Trimmer

29602	Cross Bracket
29603	Blade Assembly Hardware

Hand Aerifier

29802	Plastic Mounting Base-Aerifier
29804	Solid Tine-Aerifier
29806	Handle Weldment-Aerifier
29807	Core Collector-Aerifier
29809	Hollow Tine-Aerifier

Du-Whipper

34201	Handle Section with End Cap
-------	-----------------------------

34202	Middle Section
34203	Tip Section
34204	Metal Cap for Handle
34205	Rubber Cap for Tip

Drag Brush

52003	Draw Bar
52004	Draw Bar Bearing Pin
52007	Hair Pin
52008	5/16" x 2" (M8-1.25 x 50 mm) Eye Bolt
52009	5/16" x 1-1/2" (M8-1.25 x 38 mm) Carriage Bolt
52010	5/16" (M8) S.A.E. Flat Washer
52012	5/16" (M8-1.25) Hex Nut
52014	Channel for Drag Brush (each)-4 Required
52015	End Angle
52016	Center Angle
52017	Hardware Package

Drag Brush Extension

52014	Channel for Extension (each)-4 Required
52015	End Angle
52057	Hardware Package
52067	Hinge (each)

Coco Fiber Drag Mat

53001	Coco Mat Only-4' x 6' (1.2 m x 1.8 m)
53002	77" (196 cm) Steel Drag Bar Tube
53003	Straight Link Coil Chain 10' (3.0 m) Length
53004	77" (196 cm) Steel Drag Bar Flat
53051	Coco Mat Only-3' x 5' (0.9 m x 1.5 m)
53052	59" (150 cm) Steel Drag Bar Tube
53054	59" (150 cm) Steel Drag Bar Flat

Magnum Maintenance and Landscape Rakes

71125	24" (61 cm) Head-Straight Tooth
71131	30" (76 cm) Head-Straight Tooth
71137	36" (91 cm) Head-Straight Tooth
71143	42" (107 cm) Head-Straight Tooth
71225	24" (61 cm) Head-Sifting Tooth
71231	30" (76 cm) Head-Sifting Tooth
71237	36" (91 cm) Head-Sifting Tooth
71243	42" (107 cm) Head-Sifting Tooth
71150	66" (168 cm) Straight Handle
71151	Gusset Braces (pair)
71152	Twist Braces (pair)
71153	1/4" x 1-3/4" (M6-1.0 x 45 mm) Bolt
71154	1/4" (M6-1.0) Nylon Lock Nut
71155	1/4" x 5/8" (M6-1.0 x 16 mm) Bolt
71156	Handle Grip

Magnum Roller Squeegees

71325	24" (61 cm) Roller-Magnum Squeegee
71326	24" (61 cm) Roller Frame Assembly
71337	36" (91 cm) Roller-Magnum Squeegee
71338	36" (91 cm) Roller Frame Assembly
71350	48" (122 cm) Roller Frame Assembly
71351	57-1/2" (146 cm) Bent Handle
71352	5/16" x 5/8" (M8-1.25 x 16 mm) Stainless Steel Bolt
71353	5/16" (M8) Stainless Steel Lock Washer
71354	1/2" (1.3 cm) Stainless Steel Axle
71355	1/4" x 1-1/2" (M6-1 x 38 mm) Bolt for Hanging Hook
71356	Hanging Hook
71151	Gusset Braces (pair)
71152	Twist Braces (pair)

71153	1/4" x 1-3/4" (M6-1 x 45 mm) Bolt
71154	1/4" (M6-1 mm) Nylon Lock Nut
71155	1/4" x 5/8" (M6-1 x 16 mm) Bolt
71156	Handle Grip

Magnum Lutes

71425	24" (61 cm) Head
71437	36" (91 cm) Head
71150	66" (168 cm) Straight Handle
71151	Gusset Braces (pair)
71152	Twist Braces (pair)
71153	1/4" x 1-3/4" (M6-1 x 45 mm) Bolt
71154	1/4" (M6-1 mm) Nylon Lock Nut
71155	1/4" x 5/8" (M6-1 x 16 mm) Bolt
71156	Handle Grip

Magnum Spiked Roller

71709	8" (20 cm) Roller Head
71717	16" (41 cm) Roller Head
71710	8" (20 cm) Frame Assembly
71718	16" (41 cm) Frame Assembly
71720	3/8" (1 cm) Stainless Steel Axle
71151	Gusset Braces (pair)
71153	1/4" x 1-3/4" (M6-1 x 16 mm) Bolt
71154	1/4" (M6-1 mm) Nylon Lock Nut
71155	1/4" x 5/8" (M6-1 x 16 mm) Bolt
71156	Handle Grip
71351	57-1/2" (146 cm) Bent Handle
71352	5/16" x 5/8" (M8-1.25 x 16 mm) Stainless Steel Bolt
71353	5/16" (M8) Stainless Steel Lock Washer

Magnum Double Duty Rake

71837	36" (91 cm) Rake Head
71150	66" (168 cm) Straight Handle
71151	Gusset Braces (pair)
71152	Twist Braces (pair)
71153	1/4" x 1-3/4" (M6-1 x 45 mm) Bolt
71154	1/4" (M6-1 mm) Nylon Lock Nut
71155	1/4" x 5/8" (M6-1 x 16 mm) Bolt
71156	Handle Grip

Magnum General Purpose Broom

72101	24" (61 cm) Broom Head with Adaptor Plate
71151	Gusset Braces (pair)
71153	1/4" x 1-3/4" (M6-1 x 45 mm) Bolt
71154	1/4" (M6-1 mm) Nylon Lock Nut
71155	1/4" x 5/8" (M6-1 x 16 mm) Bolt
71156	Handle Grip
71351	57-1/2" (146 cm) Bent Handle

Magnum Maximum Duty Broom

72126	28" (71 cm) Head
72127	27-3/4" (70 cm) Bristle
72128	End Cap
72129	#8 X 5/8" (M4-0.7 x 16 mm) Screw
71151	Gusset Braces (pair)
71152	Twist Braces (pair)
71153	1/4" x 1-3/4" (M6-1 x 45 mm) Bolt
71154	1/4" (M6-1 mm) Nylon Lock Nut
71155	1/4" x 5/8" (M6-1 x 16 mm) Bolt
71156	Handle Grip
71351	57-1/2" (146 cm) Bent Handle

Magnum Monster Broom

72151	Broom Head
-------	------------

72152	40" (102 cm) Straight Handle
72153	Curved Handle with Grip
72154	83-3/4" (213 cm) Bristle
71153	1/4" x 1-3/4" (M6-1 x 45 mm) Bolt
71154	1/4" (M6-1 mm) Nylon Lock Nut
71355	1/4" x 1-1/2" (M6-1 x 38 mm) Bolt for Hanging Hook
71356	Hanging Hook
72128	End Cap
72129	#8 X 5/8" (M4-0.7 x 16 mm) Screw

Magnum Straight Edge Squeegee

72225	24" (61 cm) Rubber Blade
72237	36" (91 cm) Rubber Blade
72226	24" (61 cm) Head
72238	36" (91 cm) Head
72227	24" (61 cm) Head Strip
72239	36" (91 cm) Head Strip
72250	1/4" x 3/4" (M6-1 x 18 mm) Bolt
72251	1/4" (M6-1 mm) K-Lock Nut
71150	66" (168 cm) Straight Handle
71151	Gusset Braces (pair)
71152	Twist Braces (pair)
71153	1/4" x 1-3/4" (M6-1 x 45 mm) Bolt
71154	1/4" (M6-1 mm) Nylon Lock Nut
71155	1/4" x 5/8" (M6-1 x 16 mm) Bolt
71156	Handle Grip

Tuffork

71154	1/4" (M6-1 mm) Nylon Lock Nut
-------	-------------------------------

Magnum Spring Brace Rake

72401	Head-Magnum Spring Brace Rake
72402	Handle-Magnum Spring Brace Rake

MARKING PAINT P. 46 - 47**E-ZEE White Tool**

55601	O-Rings (pair)
55602	Rubber Washer

PRACTICE GREEN MARKERS P. 48 - 51**Practice Green Targets**

20120	Knob-Black
-------	------------

Practice Green Markers and Flags

Specify numbers when ordering

20392	Pennant White/Red Single w/Rod & Base
20492	Pennant White/Grn Single w/Rod & Base
20592	Pennant Black/Yellow Single w/Rod & Base
20393	Pennant White/Red Head & Rod
20493	Pennant White/Green Head & Rod
20593	Pennant Black/Yellow Head & Rod
20612	Nylon Flag-Small Tube-Red/White Single
20712	Nylon Flag-Small Tube-White/Red Single
20812	Nylon Flag-Small Tube-Yellow/Black Single
20692	Nylon Flag-Small Tube-Red/White Single w/Rod, Base & Knob
20792	Nylon Flag-Small Tube-White/Red Single w/Rod, Base & Knob
20892	Nylon Flag-Small Tube-Yellow/Black Single w/Rod, Base & Knob
20594	Nylon Flag-Small Tube-Plain Green Single
20694	Nylon Flag-Small Tube-Plain Red Single
20794	Nylon Flag-Small Tube-Plain White Single
20894	Nylon Flag-Small Tube-Plain Yellow Single
20994	Nylon Flag-Small Tube-Plain Blue Single

20672	Nylon Flag Large Tube-R/W Single w/Rod, Base & Knob
20772	Nylon Flag Large Tube-W/R Single w/Rod, Base & Knob
20872	Nylon Flag Large Tube-Y/B Single w/Rod, Base & Knob
20596	Nylon Flag-Large Tube-Plain Green Single
20696	Nylon Flag-Large Tube-Plain Red Single
20796	Nylon Flag-Large Tube-Plain White Single
20896	Nylon Flag-Large Tube-Plain Yellow Single
20996	Nylon Flag-Large Tube-Plain Blue Single
20912	Nylon Flag-Small Tube-Black/White Checkered Single
20922	Nylon Flag-Small Tube-Red/White Checkered Single
20932	Nylon Flag-Small Tube-Black/Yellow Checkered Single
20942	Nylon Flag-Small Tube-Green/White Checkered Single
20917	Nylon Flag-Large Tube-Black/White Checkered Single
20927	Nylon Flag-Large Tube-Red/White Checkered Single
20937	Nylon Flag-Large Tube-Black/Yellow Checkered Single
20947	Nylon Flag-Large Tube-Green/White Checkered Single
20787	Nylon Flag -Large Tube U.S. Flag Replica Single
20987	Nylon Flag-Small Tube-U.S. Flag Replica Single
25712	250 Denier Practice Green Flag-Small Tube-White Single
25722	250 Denier Practice Green Flag-Large Tube-White Single

RANGE EQUIPMENT & ACCESSORIES P. 52 - 58**Magnum Harvester Ball Picker**

80600	Back Gang Assembly
81200	A-Frame
81300	Gang Pin Assembly
81501	Spacer-Drum Assembly
81503	Plastic Disc-.76" Diameter
81600	Hub Weldment-Drum Assembly
81700	Semi-Pneumatic Tire with Hub
81900	Coated Gang with Bushings
82000	Gang Drum Assembly
82001	Plastic Disc-1.02" Diameter
82002	Axle Shaft
82100	Tie Rod Weldment-10 Disc
82200	Tie Rod Weldment-9 Disc
82300	Axle Tube Weldment
82400	Pivot Bracket
82500	Push Frame
82600	Left Arm Extension
82700	Right Arm Extension
83101	Bushing
83102	Pin Collar
83103	Pivot Pin
83107	Extend Pin-Left Arm Extension
83111	Gang Drum Spacer
83115	Compression Spring
83116	Pillow Block Bearing
83117	Double-Seal O-Ring
83118	1-1/2" (3.8 cm) Square End Cap

83120	1-1/4" (3.2 cm) Square Cap Plug
83121	Rubber Tip-Basket
83122	1" x 2" (3 cm x 5 cm) Rectangular Plug-Black
83123	5/16" x 1-1/4" Lynch Pin
83124	Pull Pin, Pivot Bracket
83200	Front Gang Pin
85501	Round Grip with Open Ends Smooth Cut-to-length
85502	Caster with Rubber Wheel

Magnum Jr. Harvester

85201	Handle
85202	Main Frame
85203	Front Axle
85204	Octagon Stem Caster
85205	Plastic Disc .76" Diameter
85206	Drum Assembly

Magnum Scrub-Pro

83116	Pillow Block Bearing
86100	Main Frame-Domestic
87100	Main Frame-Export
86200	Drum Weldment
86300	Motor Hood-Domestic
87300	Motor Hood-Export
86400	Tub-Top & Bottom
86401	Liner/Guide Set
86402	Rubber Liner-1-3/4" x 12-7/8" (4 cm x 33 cm)
86403	Rubber Liner-1-3/4" x 19-1/2" (4 cm x 50 cm)
86404	Rubber Liner-1-3/4" x 20-3/8" (4 cm x 52 cm)
86405	Rubber Latch
86406	Exit Chute
86500	Wire Basket
86600	Gear Motor-AC-40 RPM-Domestic
86703	Coupler Set
86800	Drum & Brush Assembly
86850	Coiled Brush
86900	PVC Drain Assembly
86951	Vibrator Motor
87600	Gear Motor-AC-40 RPM-Export

Range Marking Pole

09797	Cap-Range Marking Pole
-------	------------------------

Range Banner Frame Assembly Kit

31001	Pressure Elbow
31002	Frame/Leg-20" (51 cm)
31003	Pressure Tee
31004	Frame-41-1/2" (105 cm)
31006	Underground Socket

Vertical Range Flags

60095	3/8"-24 (M10-1.25) Nylon Insert Hex Flange Locknut
60096	Rod-Vertical Range Flag
60051	Vertical Range Flag Only-Yellow/Black-50
60101	Vertical Range Flag Only-Yellow/Black-100
60151	Vertical Range Flag Only-Yellow/Black-150
60201	Vertical Range Flag Only-Yellow/Black-200
60251	Vertical Range Flag Only-Yellow/Black-250
60511	Vertical Range Flag Only-Red
60521	Vertical Range Flag Only-White
60531	Vertical Range Flag Only-Yellow
60541	Vertical Range Flag Only-Orange
60551	Vertical Range Flag Only-Medium Blue

60561	Vertical Range Flag Only-Green
60571	Vertical Range Flag Only-Black

Green Line Recycle Bag Stand

200914	Cup Holder-Bag Stands
--------	-----------------------

Yardage Easel

200923	Aluminum Slider-Yardage Easels
200924	Easel Numbers-2" x 3" (5 cm x 8 cm)- Black on White (each)

SIGNS P. 62 - 68**Tee Markers and Signs**

05305	Aluminum Button Only-Saf-T Marker
05404	5" (13 cm) Stake-TurfStone Sign, Broken Tee Caddie
05804	3-1/2" (9 cm) Stake-TurfStone Tee Marker
07106	9" x 12" (23 cm x 30 cm) TurfStone Sign Gray Granite-Plain
08701	5" x 12" (13 cm x 30 cm) One-Piece Aluminum Sign-90 Degree Rule
08706	5" x 12" (13 cm x 30 cm) One-Piece Aluminum Sign-Keep Golf Carts 30' From Green
08713	5" x 12" (13 cm x 30 cm) One-Piece Aluminum Sign-Putting Green Closed
08429	6" x 12" (15 cm x 30 cm) Bracket w/Stake
09104	5-1/2" (14 cm) Stake
10014	9-1/2" (24 cm) Stake
10331	Aluminum Sign 12" x 12" (30 cm x 30 cm) Plain White
10332	Dry Erase Marker-Black

Green Line

200916	1/4" x 4-1/2" Spike-Signs/Tee Markers
200917	3/8" x 8" Spike-Stakes

Decals

09161	Fairway Sign-Carts on Path Only- Green/White (each)
09162	Fairway Sign-Drop Area-Green/White (each)
09162E	Fairway Sign-Zona de Dropaje-Green/White (each)
09162F	Fairway Sign-Dropping Zone-Green/White (each)
09163	Fairway Sign-Ground Under Repair- Green/White (each)
09163D	Fairway Sign-Boden in Ausbesserung- Green/White (each)
09163E	Fairway Sign-Terreno en Reparacion- Green/White (each)
09163F	Fairway Sign-Terrain en Reparation- Green/White (each)
09164	Fairway Sign-Keep Carts 30' From Green- Green/White (each)
09165	Fairway Sign-No Carts-Green/White (each)
09166	Fairway Sign-Please Repair Ball Marks- Green/White (each)
09166D	Fairway Sign-Bitte Pitchmarks Ausbessern- Green/White (each)
09166E	Fairway Sign-Reparare Las Marcas de Pelota Por Favor-Green/White (each)
09166F	Fairway Sign-Relevez vos Pitches- Green/White (each)
09167	Fairway Sign-Replace Divots-Green/White (each)
09167D	Fairway Sign-Bitte Divots Zurucklegen- Green/White (each)

09167E	Fairway Sign-Reponga Las Chuleta Por Favor- Green/White (each)
09167F	Fairway Sign-Replacez vos Divos S'il Vous Plait- Green/White (each)
09182	Fairway Sign-Drop Area-Green/Tan (each)
09183	Fairway Sign-Ground Under Repair- Green/Tan (each)
09184	Fairway Sign-Keep Carts 30' From Green- Green/Tan (each)
09185	Fairway Sign-No Carts-Green/Tan (each)
09186	Fairway Sign-Please Repair Ball Marks- Green/Tan (each)
09187	Fairway Sign-Replace Divots-Green/Tan (each)
10001	15" (38 cm) Arrow-Carts-Yellow/Black (pair)
10003	15" (38 cm) Arrow-Next Tee-Yellow/Black (pair)
10005	15" (38 cm) Arrow-Golf Cars-Yellow/Black (pair)
10051	15" (38 cm) Arrow-Carts-Green/White (pair)
10051D	15" (38 cm) Arrow-Caddywagen- Green/White (pair)
10051E	15" (38 cm) Arrow-Carritos-Green/White (pair)
10051F	15" (38 cm) Arrow-Chariots-Green/White (pair)
10053	15" (38 cm) Arrow-Next Tee-Green/White (pair)
10053D	15" (38 cm) Arrow-Nachster Abschlag- Green/White (pair)
10053E	15" (38 cm) Arrow-Proximo Tee- Green/White (pair)
10053F	15" (38 cm) Arrow-Depart Suivant- Green/White (pair)
10055	15" (38 cm) Arrow-Golf Cars-Green/White (pair)
10055D	15" (38 cm) Arrow-Golfwagen-Green/White (pair)
10055E	15" (38 cm) Arrow-Carritos de Golf- Green/White (pair)
10055F	15" (38 cm) Arrow-Voitures de Golf- Green/White (pair)
10057	15" (38 cm) Arrow-No. Tee-Green/White (pair)
10061	15" (38 cm) Arrow-Buggies-Green/White (pair)
10063	15" (38 cm) Arrow-Trolleys-Green/White (pair)
10077	15" (38 cm) Arrow-No. Tee-Green/Tan (pair)
10101	11" (28 cm) Arrow-Carts-Yellow/Black (pair)
10103	11" (28 cm) Arrow-Next Tee-Yellow/Black (pair)
10105	11" (28 cm) Arrow-Golf Cars-Yellow/Black (pair)
10151	11" (28 cm) Arrow-Carts-Green/White (pair)
10151D	11" (28 cm) Arrow-Caddywagen-Green/White (pair)
10151E	11" (28 cm) Arrow-Carritos-Green/White (pair)
10151F	11" (28 cm) Arrow-Chariots-Green/White (pair)
10153	11" (28 cm) Arrow-Next Tee-Green/White (pair)
10153D	11" (28 cm) Arrow-Nachster Abschlag- Green/White (pair)
10153E	11" (28 cm) Arrow-Proximo Tee-Green/White (pair)
10153F	11" (28 cm) Arrow-Depart Suivant-Green/White (pair)
10155	11" (28 cm) Arrow-Golf Cars-Green/White (pair)
10155D	11" (28 cm) Arrow-Golfwagen-Green/White (pair)
10155E	11" (28 cm) Arrow-Carritos de Golf-Green/White (pair)
10155F	11" (28 cm) Arrow-Voitures de Golf-Green/White (pair)
10161	11" (28 cm) Arrow-Buggies-Green/White (pair)
10163	11" (28 cm) Arrow-Trolleys-Green/White (pair)
10173	11" (28 cm) Arrow-Next Tee-Green/Tan (pair)
10175	11" (28 cm) Arrow-Golf Cars-Green/Tan (pair)
10189	11" (28 cm) Arrow-FootGolf-Blue/White (pair)

SPIKE KLEENERS P. 69 - 70**Scrusher**

14104	Screw-Side Brush (1)
-------	----------------------

Boot Cleaner

14210	Steel Spike Brush Only-Boot Cleaner
14211	Alternative Spike Brush Only-Boot Cleaner

Spike Kleener

14301	Base Only-Red
14401	Base Only-Green
14701	Base Only-Black
14203	3-1/2" (9 cm) Spike (1)
14204	Screw (1)

TEE CONSOLES P. 71 - 75**Console and Stand**

65206	Ball Washer Bracket
36108	Console Spike Kleener Base-Black
36156	Console Spike Kleener-Alternative Spikes-Gray
36201	Tripod Base Only-Black
36202	Console Spike Kleener Bracket Only-Black
36204	Junior Console Post Assembly Only-Black
36205	18" (46 cm) Ground Anchor
36229	Ball Washer Stand Hardware
36234	34" (86 cm) Post Only for Tradition Console-Black
36280	Aluminum Base Only for Tradition Console-Black
14203	3-1/2" (9 cm) Spike (1)

TurfStone Consoles and Tee Signs

65207	Litter Caddie Bracket-TurfStone Posts
65208	Sign Bracket Only for Optional Post Mount
65313	Bracket Only 6" x 8" (15 cm x 20 cm) Donor Sign
67504	TurfStone Junior Post Assembly Only-Black
36201	Tripod Base Only-Black
36205	18" (46 cm) Ground Anchor

TEE MARKERS P. 76 - 80**Broken Tee Caddie**

19002	Decal-Broken Tee-White
19004	Decal-Broken Tee-Black
05404	5" (13 cm) Stake

TRASH CONTAINERS P. 82 - 84**Litter Mate**

12982	Hoop Frame
12983	Pole Mounting Bracket
12984	Back Clamp
12985	Low Stand
12986	Wall Mount Bracket
12987	Double Hardware Kit
12988	Single Hardware Kit

Litter Caddie

13002	30 Gallon (114 L) Base Only
13004	12" (30 cm) Spike Only-20 (76 L) or 30 (114 L) Gallon
13104	4-3/4" (12 cm) Spike Only-9 Gallon (34 L)
13105	10" (25 cm) Long Spike Only-9 Gallon (34 L)
13202	9 Gallon (34 L) Base Only
13851	Nylon Ties-Black-9 Gallon (34 L) Litter Caddie Liner
13902	20 Gallon (76 L) Stainless Steel Base Only

Green Line Accessories

200903	Square Trash Liner-16 Gallon (61 L)
200904	Square Trash Liner-26 Gallon (98 L)

200905	Round Trash Liner-3.5 Gallon (13 L)
200906	Round Trash Liner-5 Gallon (19 L)
200908	Round Trash Liner-20 Gallon (76 L)
200909	Round Trash Liner-32 Gallon (121 L)
200910	Round Trash Container-10 Gallon (38 L)
200911	Round Trash Container-20 Gallon (76 L)
200912	Round Trash Container-32 Gallon (121 L)
200913	Round Trash Container-44 Gallon (167 L)

WATER STATIONS P. 85 - 87**Kooler-Aid**

40126	Kooler-Aid Top-Red
40151	Kooler-Aid Top-Green
40171	Kooler-Aid Top-Black
40200	Kooler-Aid Stand, Black
36201	Tripod Base Only-Black
40204	Post Assembly Only-Black
40205	Kooler-Aid Tray, Black
40129	Kooler-Aid Top Hardware
40177	Ball Knob
40229	Kooler-Aid Stand Hardware
45305	Cup Dispenser Mounting Bracket
45315	Spigot for Plastic Cooler
45605	Lid for Cup Dispenser

Jr. Kooler-Aid

36201	Tripod Base Only-Black
40204	Post Assembly Only-Black

Water Purification System

49002	Pump Assembly, Complete
49003	Ice Guard

YARDAGE MARKERS P. 88 - 90

09311	PVC Marker Decal-Red/White 100
09321	PVC Marker Decal-Clear/Black 150
09331	PVC Marker Decal-Blue/White 200
09341	PVC Marker Decal-Yellow/Black 250
09361	Decal 1-Stripe German-Style Marker
09362	Decal 2-Stripe German-Style Marker
09363	Decal 3-Stripe German-Style Marker

Fairway Marking Poles

09701	Striped Pole Only (each)
09702	Cap for Fairway Marking Pole
31006	Underground Socket

PROLINE P. 91**Ball Rack**

02203	Pipe Only
-------	-----------

Golf Cart Flag Identification System

09419	5/16" (0.8 cm) Acorn Nut-Black
09811	Cart Flag White/Red "Players Assistant"
09812	Cart Flag Blue/White Disabled Symbol
09813	Cart Flag Red/White "Marshal"
09820	White Rod for Cart Flags
09830	Spring Clamp Assembly for Cart Flags
09831	Threaded Aluminum Block
20987	Cart Flag-Sewn U.S. Flag

Short Game Target System

50200	Short Game Target Hoop
50201	Sign Adapter-Short Game Target

STANDARD GOLF COMPANY

6620 Nordic Drive
P.O. Box 68
Cedar Falls, Iowa 50613, USA
phone: 319-266-2638
fax: 319-266-9627

1-866-743-9773

email: info@StandardGolf.com
StandardGolf.com

Standard Golf products are available worldwide through a network of outstanding Distributors.

For the name of the Distributor nearest you, contact us toll-free at 1-866-743-9773.



DISTRIBUTED BY

WARRANTY: Standard Golf Company warrants its products to be free from defects in materials and workmanship within a period of one year from the date of purchase. Standard Golf's sole responsibility under this warranty shall be to repair, replace or refund the price of the defective product or component. All such repairs, refunds and replacements are subject to such rules, terms and conditions as Standard Golf may promulgate from time to time.

DISCLAIMER OF OTHER WARRANTIES: The foregoing limited warranty is in lieu of all other warranties, expressed or implied, including merchantability or fitness for a particular purpose. In no event shall Standard Golf be liable for any indirect, consequential or special damages of any nature whatsoever.

IMPORTANT NOTICE: United States Golf Association logos appearing in this catalog are for illustrative purposes only. They do not imply endorsement by the owners of the designs.

The use of the word 'tour' in connection with any product in this catalog does not imply a relationship with, or an endorsement by PGA TOUR, Inc.

Sizes, weights, dimensions and descriptions given in this catalog are nominal only, and may change slightly from time to time due to changes in materials and production methods. Colors are approximate, and may change slightly among different products.

Prices shown in this catalog are effective January 1, 2019 and are subject to change without notice.

© 2019 Standard Golf Company.

Printed in USA 

Standard Golf, the Standard Golf logo and Venti-Knit are registered trademarks and Tour Pro, Gator Grip, All-Flex, Green Line, Tour Smooth, Magnum, Tradition, Premier, Medalist, Sparkleen, Duo-Rake, Tour-Lite, Smart-Fit, Cup Caddie, Snap-

Lock, Royaline, Flagstick Caddie, Harvester, Easymark, Holemaster, Turf Doctor, Du-Whipper, Levelawn, TurfStone, Scrub-Pro, Bag Caddie, Turf Guard, Eco-Step, E-Zee, Scrusher, Spike Kleener, Duo-Kleener, Litter Caddie, LitterMate, Caddie Covers, Kooler-Aid and Cooler Cover Lock are trademarks owned by Standard Golf Company.

All other trademarks, registered trademarks and service marks are the property of their respective owners.

The photography in this catalog was taken at Glen Oaks Country Club, Beaver Hills Country Club, Des Moines Golf & Country Club, Quarry Oaks Golf Course and the Country Club in Lincoln. We at Standard Golf greatly appreciate the opportunity to showcase our products on these fine courses, and we would like to thank the following: Superintendent Rick Tegtmeier and Golf Pro Scott Howe – Des Moines Golf & Country Club; Superintendent Ken Cuddy and Golf Pro Joe Sutter – Quarry Oaks; Superintendent Ben Messerly – the Country Club of Lincoln; Superintendent Josh Petersen and Golf Pro Brad Clark – Beaver Hills Country Club; and Superintendent Chris Coen and Reed Warman – Glen Oaks Country Club.

STANDARD GOLF IS PROUD TO SUPPORT THESE INDUSTRY ASSOCIATIONS:



Silver Partner • Golf Course Superintendents Association of America



National Golf Course Owners Association



Canadian Golf Superintendents Association



Iowa Golf Course Superintendents Association



National Golf Foundation



Golf Coaches Association of America